Keysight 2-Port and 4-Port PNA Network Analyzer

N5227B 900 Hz to 67 GHz

(for synthesizer revision 7)

Documentation Warranty

THE MATERIAL CONTAINED IN THIS DOCUMENT IS PROVIDED "AS IS," AND IS SUBJECT TO BEING CHANGED, WITHOUT NOTICE, IN FUTURE EDITIONS. FURTHER, TO THE MAXIMUM EXTENT PERMITTED BY APPLICABLE LAW, KEYSIGHT DISCLAIMS ALL WARRANTIES, EITHER EXPRESS OR IMPLIED WITH REGARD TO THIS MANUAL AND ANY INFORMATION CONTAINED HEREIN, INCLUDING BUT NOT LIMITED TO THE IMPLIED WARRANTIES OF MERCHANTABILITY AND FITNESS FOR A PARTICULAR PURPOSE. KEYSIGHT SHALL NOT BE LIABLE FOR ERRORS OR FOR INCIDENTAL OR CONSEQUENTIAL DAMAGES IN CONNECTION WITH THE FURNISHING, USE, OR PERFORMANCE OF THIS DOCUMENT OR ANY INFORMATION CONTAINED HEREIN. SHOULD KEYSIGHT AND THE USER HAVE A SEPARATE WRITTEN AGREEMENT WITH WARRANTY TERMS COVERING THE MATERIAL IN THIS DOCUMENT THAT CONFLICT WITH THESE TERMS, THE WARRANTY TERMS IN THE SEPARATE AGREEMENT WILL CONTROL.

U.S. Government Rights

U.S. Government Rights. The Software is "commercial computer software," as defined by Federal Acquisition Regulation ("FAR") 2.101. Pursuant to FAR 12.212 and 27.405-3 and Department of Defense FAR Supplement ("DFARS") 227.7202, the U.S. government acquires commercial computer software under the same terms by which the software is customarily provided to the public. Accordingly, Keysight provides the Software to U.S. government customers under its standard commercial license, which is embodied in its End User License Agreement (EULA), a copy of which can be found at <http://www.keysight.com/find/sweula>. The license set forth in the EULA represents the exclusive authority by which the U.S. government may use, modify, distribute, or disclose the Software. The EULA and the license set forth therein, does not require or permit, among other things, that Keysight: (1) Furnish technical information related to commercial computer software or commercial computer software documentation that is not customarily provided to the public; or (2) Relinquish to, or otherwise provide, the government rights in excess of these rights customarily provided to the public to use, modify, reproduce, release, perform, display, or disclose commercial computer software or commercial computer software documentation. No additional government requirements beyond those set forth in the EULA shall apply, except to the extent that those terms, rights, or licenses are explicitly required from all providers of commercial computer software pursuant to the FAR and the DFARS and are set forth specifically in writing elsewhere in the EULA. Keysight shall be under no obligation to update, revise or otherwise modify the Software. With respect to any technical data as defined by FAR 2.101, pursuant to FAR 12.211 and 27.404.2 and DFARS 227.7102, the U.S. government acquires no greater than Limited Rights as defined in FAR 27.401 or DFAR 227.7103-5 (c), as applicable in any technical data.

Table of Contents

Documentation Warranty	2
U.S. Government Rights	2
Table 1. Low-Frequency Extension (LFE) Options	7
Definitions	8
Dynamic Range	10
System Dynamic Range	11
Table 2. System Dynamic Range at Test Port (dB), Options 200 or 400	11
Table 3. System Dynamic Range at Test Port (dB), Options 201 or 401	12
Table 4. System Dynamic Range at Test Port (dB), Options 219 or 419	13
Table 5. System Dynamic Range at Test Port (dB), Options 205, 405	14
Table 6. System Dynamic Range at Test Port (dB), Options 220, 420	15
Table 7. System Dynamic Range at Test Port (dB), All LFE Options (LFE Enabled)	16
Extended Dynamic Range	17
Table 8. Extended Dynamic Range at Direct Receiver Access Input (dB) - Typical	17
Table 9. Extended Dynamic Range at Direct Receiver Access Input (dB) - Typical	18
Receiver Dynamic Range	19
Table 10. Receiver Dynamic Range (dB), All Options	19
Table 11. Receiver Dynamic Range (dB), All Ports, All LFE Options (LFE Enabled)	19
Corrected System Performance, All Options	20
Table 12. N5227B with 85058B Calibration Kit	20
Transmission Uncertainty, All Options	21
Reflection Uncertainty, All Options	22
Table 13. N5227B with N4694A 2-Port Electronic Calibration Module	23
Transmission Uncertainty, All Options	24
Reflection Uncertainty, All Options	25
Table 14. N5227B with N4694D 2-Port Electronic Calibration Module	26
Transmission Uncertainty, All Options	27
Reflection Uncertainty, All Options	28
Table 15. N5227B with 85058B Calibration Kit, All LFE Options (LFE Enabled)	29
Transmission Uncertainty, All LFE Options	29
Reflection Uncertainty, All LFE Options	29
Table 16. N5227B with N4694D Calibration Kit, All LFE Options (LFE Enabled)	30
Transmission Uncertainty, All LFE Options	31
Reflection Uncertainty, All LFE Options	31
Uncorrected System Performance	32
Table 17. Error Terms (dB), All Ports, All Options - Specifications	32
Table 18. Error Terms (dB), All Ports, All LFE Options (LFE Enabled) - Specifications	32

Table 19. Error Terms (dB), All Ports, All Options - Typical	33
Table 20. Error Terms (dB), All Ports, All LFE Options (LFE Enabled) - Typical.....	33
Test Port Output.....	34
Table 21. Frequency Information, All Options.....	34
Table 22. Maximum Leveled Power (dBm), All Ports - Specification	34
Table 23. Maximum Leveled Power (dBm), All Ports - Typical.....	35
Table 24. Maximum Leveled Power (dBm) – All LFE Options - Specification.....	36
Table 25. Maximum Leveled Power (dBm) – All LFE Options - Typical.....	37
Table 26. Maximum Power (dBm), All Ports – All LFE Options (LFE Enabled)	38
Table 27. Power Level Accuracy (dB) at Nominal Power ¹ , All Options	38
Table 28. Power Level Accuracy (dB), All Ports, All LFE Options (LFE Enabled).....	39
Table 29. Power Level Linearity ¹ (dB), All Options - Specification	39
Table 30. Power Level Linearity ¹ (dB), All Options - Specification	39
Table 31. Power Level Linearity ¹ (dB), All Ports, All LFE Options (LFE Enabled)	40
Table 32. Power Sweep Range (dB), All Ports - Specification	40
Table 33. Power Sweep Range (dB), All Ports - Typical	41
Table 34. Power Sweep Range (dB) – All LFE Options - Specification	42
Table 35. Power Sweep Range (dB) – All LFE Options - Typical.....	43
Table 36. Power Sweep Range (dB) – All LFE Options (LFE Enabled).....	44
Table 37. Nominal Power (Preset Power, dBm).....	44
Table 38. Power Resolution and Maximum/Minimum Settable Power, All Models and Options.....	44
Table 39. 2 nd and 3 rd Harmonics at Max Specified Power (dBc), All Options - Typical	45
Table 40. 2 nd and 3 rd Harmonics at Max Specified Power (dBc), All Ports, All LFE Options (LFE Enabled) - Typical.....	45
Table 41. Non-Harmonic Spurs ¹ at Nominal Power (dBc), All Models and Options – Typical	46
Tracking Spurs (Linear Frequency Scale)	46
Tracking Spurs (Logarithmic Frequency Scale).....	47
Table 42. Phase Noise (dBc/Hz), All Options, with UNY, Port 1, 3 - Typical.....	47
Table 43. Phase Noise (dBc/Hz), All Options, with UNY, Port 2, 4 - Typical.....	47
Table 44. Phase Noise (dBc/Hz), All Options, with UNY, All Ports – Supplemental Performance Data	48
Phase Noise with Option UNY (Typical)	48
Phase Noise with Option UNY (Supplemental Performance Data)	49
Table 45. Phase Noise (dBc/Hz) All LFE Options (LFE Enabled), with UNY, All Ports - Typical.....	49
Table 46. Phase Noise (dBc/Hz), All Options, without UNY, All Ports - Typical.....	49
Table 47. Phase Noise (dBc/Hz), All Options, without UNY, All Ports – Supplemental Performance Data	50
Phase Noise, CW 10 GHz, with Option UNY and without Option UNY.....	50
Test Port Input.....	51
Table 48. Noise Floor (dBm) @ 10 Hz IFBW, All Options, All Ports.....	51

Table 49. Test Port Noise Floor (dBm) @ 10 Hz IFBW, All LFE Options (LFE Enabled)	51
Table 50. Direct Receiver Access Input Noise Floor (dBm) @ 10 Hz IFBW	52
Table 51. 0.1 dB Receiver Compression at Test Port (dBm), Option 201, 219, 401, 419, and All LFE Options - Typical	52
Table 52. 0.1 dB Compression, All Ports, All LFE Options (LFE Enabled) - Typical.....	53
Table 53. Receiver Compression at Test Power - Specification.....	53
Table 54. Compression, All Ports, All LFE Options (LFE Enabled)- Specification	54
Table 55. Trace Noise ¹ Magnitude (dB rms).....	54
Table 56. Trace Noise ¹ Magnitude (dB rms), All Ports, All LFE Options (LFE Enabled).....	55
Table 57. Trace Noise ¹ Phase (deg rms), All Options	55
Table 58. Trace Noise ¹ Phase (deg rms), All Ports, All LFE Options (LFE Enabled).....	55
Table 59. Reference Level Magnitude, All Models and Options - Specification.....	56
Table 60. Stability, All Options - Typical	56
Table 61. Stability ¹ , All LFE Options (LFE Enabled) - Typical	56
Table 62. Damage Input Level, All Ports	56
Phase Noise Measurement Performance (with S930317B phase noise measurement application)	57
Table 63. Absolute Phase Noise Sensitivity (dBc/Hz), in Best mode - Supplemental Performance Data	57
Table 64. Absolute AM Noise Sensitivity (dBc/Hz), in Best mode - Supplemental Performance Data	57
Absolute Phase Noise Sensitivity (dBc/Hz) - Supplemental Performance Data.....	58
Single-Channel Residual Noise Measurement	59
Table 65. Single-Channel Residual Phase Noise Sensitivity (dBc/Hz), with Option UNY in Best mode - Supplemental Performance Data	59
Table 66. Single-Channel Residual AM Noise Sensitivity (dBc/Hz), with Option UNY in Best mode - Supplemental Performance Data	59
Single-Channel Residual Phase Noise Sensitivity (dBc/Hz) - Supplemental Performance Data.....	60
Table 67. Single-Channel Residual Phase Noise Sensitivity (dBc/Hz), without Option UNY in Best mode - Supplemental Performance Data	61
Table 68. Single-Channel Residual AM Noise Sensitivity (dBc/Hz), without Option UNY in Best mode - Supplemental Performance Data	61
2-Channel Residual Noise Measurement for Non-Frequency Converting Devices.....	62
Table 69. 2-Channel Residual Phase Noise Sensitivity (dBc/Hz) in Best mode - Supplemental Performance Data	62
Table 70. 2-Channel Residual AM Noise Sensitivity (dBc/Hz) in Best mode - Supplemental Performance Data.....	62
2-Channel Residual Phase Noise Sensitivity (dBc/Hz) - Supplemental Performance Data.....	63
Dynamic Accuracy	64
Table 71. N5227B Dynamic Accuracy - Specification	64
N5227B Dynamic Accuracy, 900 Hz, All LFE Options (LFE Enabled) - Specification.....	64
N5227B Dynamic Accuracy, 10 MHz, All LFE Options (LFE Enabled) - Specification.....	64
N5227B Dynamic Accuracy, 100 MHz, All LFE Options (LFE Enabled) - Specification.....	65

N5227B Dynamic Accuracy, 10 MHz - Specification	65
N5227B Dynamic Accuracy, 50 MHz - Specification	65
N5227B Dynamic Accuracy, 500 MHz - Specification	66
N5227B Dynamic Accuracy, 1 GHz - Specification	66
N5227B Dynamic Accuracy, 2 GHz - Specification	66
N5227B Dynamic Accuracy, 20 GHz - Specification	67
N5227B Dynamic Accuracy, 26.5 GHz - Specification	67
N5227B Dynamic Accuracy, 35 GHz - Specification	67
N5227B Dynamic Accuracy, 40 GHz - Specification	68
N5227B Dynamic Accuracy, 50 GHz - Specification	68
N5227B Dynamic Accuracy, 60 GHz - Specification	69
N5227B Dynamic Accuracy, 67 GHz - Specification	69
Table 72. Group Delay ¹ - Typical	70
General Information	71
Table 73. Miscellaneous Information	71
Table 74. Front Panel Information, All Options	71
Table 75. Rear Panel Information, All Options.....	72
Table 76. Analyzer Dimensions and Weight.....	75
Regulatory and Environmental Information.....	75
Measurement Throughput Summary	76
Table 77. Cycle Time (ms) for Measurement Completion, All Models, All Options - Typical	76
Table 78. Cycle Time (ms) for Full-Span Measurement Completion - Typical	76
Table 79. Cycle Time vs. IF Bandwidth - Typical.....	77
Table 80. Cycle Time (ms) vs. Number of Points - Typical.....	78
Table 81. Data Transfer Time ¹ (ms) - Typical.....	79
Front-Panel Jumpers.....	80
Table 82. Measurement Receiver Inputs (dBm) - Typical	80
Table 83. Port 1 Reference Receiver Inputs and Reference Source Outputs (dBm) - Typical	81
Table 84. Port 2, 3, 4 Reference Receiver Inputs and Reference Source Outputs (dBm) - Typical	82
Table 85. Source Outputs (dBm) - Typical.....	83
Table 86. Coupler Inputs (dB) - Typical	84
Table 87. Damage Level - Typical	84
Test Set Block Diagrams.....	85

This is a complete list of the technical specifications for the N5227B PNA network analyzer with the following options (see block diagrams at the end of this document):

2-Port Models

Option 200 - 2-port base model with standard test set.

Option 201 - To base model, adds front-panel jumpers and R1 receiver switch.

Option 219 - To base model, adds front-panel jumpers, R1 receiver switch, source and receiver attenuators (extended power range), and bias-tees.

4-Port Models

Option 400 - 4-port base model with standard test set.

Option 401 - To base model, adds front-panel jumpers and R1 receiver switch.

Option 419 - To base model, adds front-panel jumpers, R1 receiver switch, source and receiver attenuators (extended power range), and bias-tees.

Table 1. Low-Frequency Extension (LFE) Options

Option	Description
2-Port Model	
205	2-port standard test set (includes six front-panel access loops), R1 receiver switch, and low frequency extension (LFE) hardware.
220	2-port standard test set (includes six front-panel access loops), R1 receiver switch, source and receiver attenuators (extended power range), bias-tees, and low frequency extension (LFE) hardware.
4-Port Models	
405	4-port standard test set (includes six front-panel access loops), R1 receiver switch, and low frequency extension (LFE) hardware.
420	4-port standard test set (includes six front-panel access loops), R1 receiver switch, source and receiver attenuators (extended power range), bias-tees, and low frequency extension (LFE) hardware.

Notes

This document provides technical specifications for the 85058B calibration kit and N4694A/D ECal module.

Please download our free Uncertainty Calculator from http://www.keysight.com/find/na_calculator to generate the curves for your calibration kit and PNA setup.

Typical performance information between 67 GHz and 70 GHz is shown in this document where available. The performance is degraded at particular frequencies in this range due to the modes of the 1.85 mm connectors used in the analyzer, test port cables and adapters.

For all tables in this document, the specified performance at the exact frequency of a break is the degraded value of the two specifications at that frequency.

Definitions

All specifications and characteristics apply over a 25 °C ±5 °C range (unless otherwise stated) and 90 minutes after the instrument has been turned on.

Specification (spec.): Warranted performance. Specifications include guardbands to account for the expected statistical performance distribution, measurement uncertainties, and changes in performance due to environmental conditions.

Characteristic (char.): A performance parameter that the product is expected to meet before it leaves the factory, but that is not verified in the field and is not covered by the product warranty. A characteristic includes the same guardbands as a specification.

Typical (typ.): Expected performance of an average unit which does not include guardbands. It is not covered by the product warranty.

Nominal (nom.): A general, descriptive term that does not imply a level of performance. It is not covered by the product warranty.

Supplemental performance data (SPD): A performance parameter that is tested on a minimal set of products during design validation. It does not include guardbands, and is not covered by the product warranty.

Calibration: The process of measuring known standards to characterize a network analyzer's systematic (repeatable) errors.

Corrected (residual): Indicates performance after error correction (calibration). It is determined by the quality of calibration standards and how well "known" they are, plus system repeatability, stability, and noise.

Uncorrected (raw): Indicates instrument performance without error correction. The uncorrected performance affects the stability of a calibration.

Standard: When referring to the analyzer, this includes no options unless noted otherwise.

Standard and LFE measurements: With an LFE option, which adds low frequency extension (LFE) hardware, the LFE measurement range overlaps with the standard measurement range from 10 MHz to 100 MHz. With LFE Enabled, measurements from 500 Hz to 100 MHz use LFE hardware. With LFE Disabled, measurements from 10 MHz to 100 MHz use standard hardware. To measure below 10 MHz, LFE must be enabled. All measurements above 100 MHz use standard hardware, regardless of the LFE Enabled/Disabled setting.

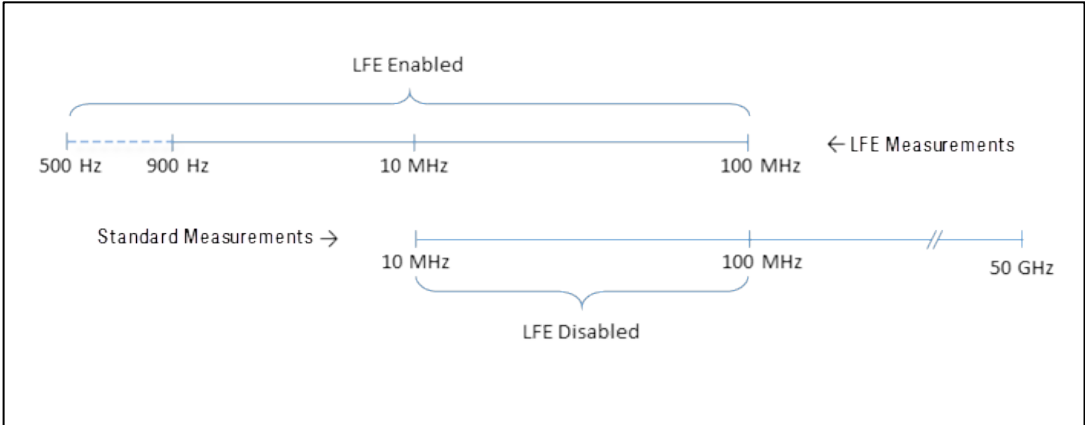

Dynamic Range

The specifications in this section apply for measurements made with the N5227B network analyzer with the following conditions:

- 10 Hz IF bandwidth
- No averaging applied to data
- Isolation calibration with an averaging factor of 8

System Dynamic Range is defined as the measured source maximum output power (A) minus the measured noise floor (B).

Extended Dynamic Range at Direct Access Input is defined as the system dynamic range (typical) less the nominal loss associated with the test port coupler.

Receiver Dynamic Range is defined as the typical test port 0.1 dB compression (C) minus the typical noise floor (D).

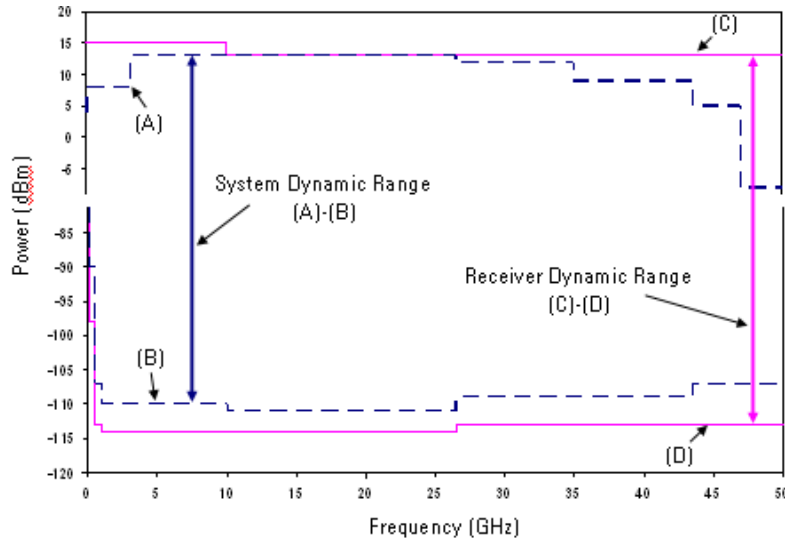

System Dynamic Range

Table 2. System Dynamic Range at Test Port (dB), Options 200 or 400

Description	Specification ²		Typical	
	Ports ¹ 1, 3	Ports ¹ 2, 4	Ports ¹ 1, 3	Ports ¹ 2, 4
10 MHz to 50 MHz	87	86	95	95
50 MHz to 100 MHz	107	108	116	117
100 MHz to 500 MHz	116	115	129	131
500 MHz to 1 GHz	127	129	135	137
1 GHz to 2 GHz	130	133	138	141
2 GHz to 3.2 GHz	127	130	134	139
3.2 GHz to 10 GHz	130	132	138	140
10 GHz to 13.5 GHz	131	130	139	139
13.5 GHz to 16 GHz	130	131	138	140
16 GHz to 19 GHz	129	129	138	138
19 GHz to 20 GHz	130	130	138	139
20 GHz to 24 GHz	130	130	138	138
24 GHz to 26.5 GHz	130	130	138	138
26.5 GHz to 30 GHz	122	120	131	129
30 GHz to 32 GHz	120	118	129	127
32 GHz to 35 GHz	121	118	129	127
35 GHz to 40 GHz	110	108	121	119
40 GHz to 43.5 GHz	116	111	127	121
43.5 GHz to 50 GHz	118	114	127	124
50 GHz to 60 GHz	116	112	126	122
60 GHz to 64 GHz	118	114	127	123
64 GHz to 67 GHz	118	114	128	125
67 GHz to 70 GHz	--	--	126	123

¹ Either port can be used as the source port. Any other port can be used as the receiver port

² Specification applies to new instruments. Test limit during recertification is defined by Maximum Levelled Power - Noise Floor.

Table 3. System Dynamic Range at Test Port (dB), Options 201 or 401

Description	Specification ²		Typical (dB)	
	Ports ¹ 1, 3	Ports ¹ 2, 4	Ports ¹ 1, 3	Ports ¹ 2, 4
10 MHz to 50 MHz	87	85	96	94
50 MHz to 100 MHz	109	107	117	116
100 MHz to 500 MHz	116	115	130	130
500 MHz to 1 GHz	128	128	136	137
1 GHz to 2 GHz	131	132	138	140
2 GHz to 3.2 GHz	128	131	135	139
3.2 GHz to 10 GHz	130	132	137	139
10 GHz to 13.5 GHz	132	130	139	138
13.5 GHz to 16 GHz	130	129	138	138
16 GHz to 19 GHz	130	130	139	138
19 GHz to 20 GHz	130	130	139	139
20 GHz to 24 GHz	130	130	138	138
24 GHz to 26.5 GHz	129	129	137	137
26.5 GHz to 30 GHz	122	121	131	130
30 GHz to 32 GHz	119	120	128	128
32 GHz to 35 GHz	120	119	128	128
35 GHz to 40 GHz	111	111	121	121
40 GHz to 43.5 GHz	115	114	125	123
43.5 GHz to 50 GHz	115	115	125	125
50 GHz to 60 GHz	115	114	124	124
60 GHz to 64 GHz	117	115	125	125
64 GHz to 67 GHz	118	117	127	127
67 GHz to 70 GHz	--	--	124	124

¹ Either port can be used as the source port. Any other port can be used as the receiver port.

² Specification applies to new instruments. Test limit during recertification is defined by Maximum Leveled Power - Noise Floor.

Table 4. System Dynamic Range at Test Port (dB), Options 219 or 419

Description	Specification ²		Typical (dB)	
	Ports ¹ 1, 3	Ports ¹ 2, 4	Ports ¹ 1, 3	Ports ¹ 2, 4
10 MHz to 50 MHz	86	86	95	94
50 MHz to 100 MHz	109	108	116	116
100 MHz to 500 MHz	116	116	130	131
500 MHz to 1 GHz	129	129	136	137
1 GHz to 2 GHz	130	133	138	140
2 GHz to 3.2 GHz	126	131	134	138
3.2 GHz to 10 GHz	130	131	137	138
10 GHz to 13.5 GHz	130	129	138	137
13.5 GHz to 16 GHz	130	129	137	137
16 GHz to 19 GHz	128	127	136	136
19 GHz to 20 GHz	128	127	136	136
20 GHz to 24 GHz	127	127	135	135
24 GHz to 26.5 GHz	127	127	135	134
26.5 GHz to 30 GHz	118	118	127	126
30 GHz to 32 GHz	116	116	125	125
32 GHz to 35 GHz	116	115	125	124
35 GHz to 40 GHz	106	106	116	116
40 GHz to 43.5 GHz	111	109	121	118
43.5 GHz to 50 GHz	111	110	120	120
50 GHz to 60 GHz	109	107	118	117
60 GHz to 64 GHz	110	108	119	118
64 GHz to 67 GHz	110	109	119	119
67 GHz to 70 GHz	--	--	116	115

¹ Either port can be used as the source port. Any other port can be used as the receiver port.

² Specification applies to new instruments. Test limit during recertification is defined by Maximum Levelled Power - Noise Floor.

Table 5. System Dynamic Range at Test Port (dB), Options 205, 405

Description	Specification ³		Typical (dB)	
	Ports ² 1, 3	Ports ² 2, 4	Ports ² 1, 3	Ports ² 2, 4
10 MHz to 50 MHz ¹	81	76	89	87
50 MHz to 100 MHz ¹	103	104	112	113
100 MHz to 500 MHz	110	112	125	126
500 MHz to 1 GHz	123	123	132	133
1 GHz to 2 GHz	130	129	137	139
2 GHz to 3.2 GHz	127	129	134	137
3.2 GHz to 10 GHz	128	128	136	137
10 GHz to 13.5 GHz	128	126	137	136
13.5 GHz to 16 GHz	128	127	137	136
16 GHz to 19 GHz	126	127	136	137
19 GHz to 20 GHz	128	128	137	137
20 GHz to 24 GHz	126	127	135	136
24 GHz to 26.5 GHz	127	127	135	136
26.5 GHz to 30 GHz	118	118	128	128
30 GHz to 32 GHz	116	117	126	126
32 GHz to 35 GHz	117	117	126	127
35 GHz to 40 GHz	107	107	119	119
40 GHz to 43.5 GHz	112	111	123	123
43.5 GHz to 50 GHz	112	113	123	124
50 GHz to 60 GHz	111	111	121	121
60 GHz to 64 GHz	111	112	122	122
64 GHz to 67 GHz	110	114	122	124
67 GHz to 70 GHz	--	--	119	119

¹ With Option 205, 405 installed and LFE disabled, applied to frequencies <= 100 MHz. Above 100 MHz, performance is the same for both LFE enabled or disabled.

² Either port can be used as the source port. Any other port can be used as the receiver port.

³ Specification applies to new instruments. Test limit during recertification is defined by Maximum Levelled Power - Noise Floor.

Table 6. System Dynamic Range at Test Port (dB), Options 220, 420

Description	Specification ³		Typical (dB)	
	Ports ² 1, 3	Ports ² 2, 4	Ports ² 1, 3	Ports ² 2, 4
10 MHz to 50 MHz ¹	79	79	88	87
50 MHz to 100 MHz ¹	105	104	112	112
100 MHz to 500 MHz	112	112	126	127
500 MHz to 1 GHz	126	126	133	134
1 GHz to 2 GHz	127	130	135	137
2 GHz to 3.2 GHz	123	128	131	135
3.2 GHz to 10 GHz	128	129	135	136
10 GHz to 13.5 GHz	128	127	136	135
13.5 GHz to 16 GHz	128	127	135	135
16 GHz to 19 GHz	126	125	134	134
19 GHz to 20 GHz	126	125	134	134
20 GHz to 24 GHz	125	125	133	133
24 GHz to 26.5 GHz	125	125	133	132
26.5 GHz to 30 GHz	117	117	126	125
30 GHz to 32 GHz	115	115	124	124
32 GHz to 35 GHz	115	114	124	123
35 GHz to 40 GHz	105	105	115	115
40 GHz to 43.5 GHz	110	108	120	117
43.5 GHz to 50 GHz	110	109	119	119
50 GHz to 60 GHz	108	106	117	116
60 GHz to 64 GHz	109	107	118	117
64 GHz to 67 GHz	109	108	118	118
67 GHz to 70 GHz	--	--	115	114

¹ With Option 220, 420 installed and LFE disabled, applied to frequencies <= 100 MHz. Above 100 MHz, performance is the same for both LFE enabled or disabled.

² Either port can be used as the source port. Any other port can be used as the receiver port.

³ Specification applies to new instruments. Test limit during recertification is defined by Maximum Leveled Power - Noise Floor.

Table 7. System Dynamic Range at Test Port (dB), All LFE Options (LFE Enabled)

Description	Specification ¹		Typical	
	Ports 1, 3	Ports 2, 4	Ports 1, 3	Ports 2, 4
500 Hz to 900 Hz	--	--	105	105
900 Hz to 1 kHz	100	102	109	110
1 kHz to 10 kHz	103	105	110	111
10 kHz to 100 kHz	113	115	120	121
100 kHz to 1 MHz	120	121	124	125
1 MHz to 5 MHz	121	122	126	127
5 MHz to 10 MHz	112	114	118	119
10 MHz to 50 MHz	110	112	116	117
50 MHz to 100 MHz	110	112	116	117

¹ Specification applies to new instruments. Test limit during recertification is defined by Maximum Leveled Power - Noise Floor.

Extended Dynamic Range

Table 8. Extended Dynamic Range at Direct Receiver Access Input (dB) - Typical

Description	Options 201, 401		Options 219, 419	
	Ports ¹ 1, 3	Ports ¹ 2, 4	Ports ¹ 1, 3	Ports ¹ 2, 4
10 MHz to 50 MHz	136	134	135	134
50 MHz to 100 MHz	145	144	144	144
100 MHz to 500 MHz	158	158	158	159
500 MHz to 1 GHz	164	165	164	165
1 GHz to 2 GHz	153	155	153	155
2 GHz to 3.2 GHz	150	154	149	153
3.2 GHz to 10 GHz	152	154	152	153
10 GHz to 13.5 GHz	153	152	152	151
13.5 GHz to 16 GHz	152	152	151	151
16 GHz to 19 GHz	153	152	150	150
19 GHz to 20 GHz	153	153	150	150
20 GHz to 24 GHz	152	152	149	149
24 GHz to 26.5 GHz	151	151	149	148
26.5 GHz to 30 GHz	145	144	141	140
30 GHz to 32 GHz	142	142	139	139
32 GHz to 35 GHz	142	142	139	138
35 GHz to 40 GHz	135	135	130	130
40 GHz to 43.5 GHz	138	136	134	131
43.5 GHz to 50 GHz	138	138	133	133
50 GHz to 60 GHz	136	136	130	129
60 GHz to 64 GHz	136	136	130	129
64 GHz to 67 GHz	138	138	130	130
67 GHz to 70 GHz	135	135	127	126

¹Either port can be used as the source port. Any other port can be used as the receiver port.

Table 9. Extended Dynamic Range at Direct Receiver Access Input (dB) - Typical

Description	Options 205, 405		Options 220, 420	
	Ports ¹ 1, 3	Ports ¹ 2, 4	Ports ¹ 1, 3	Ports ¹ 2, 4
10 MHz to 50 MHz	129	127	128	127
50 MHz to 100 MHz	140	141	140	140
100 MHz to 500 MHz	153	154	154	155
500 MHz to 1 GHz	160	161	161	162
1 GHz to 2 GHz	152	154	150	152
2 GHz to 3.2 GHz	149	152	146	150
3.2 GHz to 10 GHz	151	152	150	151
10 GHz to 13.5 GHz	151	150	150	149
13.5 GHz to 16 GHz	151	150	149	149
16 GHz to 19 GHz	150	151	148	148
19 GHz to 20 GHz	151	151	148	148
20 GHz to 24 GHz	149	150	147	147
24 GHz to 26.5 GHz	149	150	147	146
26.5 GHz to 30 GHz	142	142	140	139
30 GHz to 32 GHz	140	140	138	138
32 GHz to 35 GHz	140	141	138	137
35 GHz to 40 GHz	133	133	129	129
40 GHz to 43.5 GHz	136	136	133	130
43.5 GHz to 50 GHz	136	137	132	132
50 GHz to 60 GHz	133	133	129	128
60 GHz to 64 GHz	133	133	129	128
64 GHz to 67 GHz	133	135	129	129
67 GHz to 70 GHz	130	130	126	125

¹Either port can be used as the source port. Any other port can be used as the receiver port.

Receiver Dynamic Range

Table 10. Receiver Dynamic Range (dB), All Options

Description	Typical
10 MHz to 50 MHz ¹	91
50 MHz to 100 MHz ¹	112
100 MHz to 500 MHz	118
500 MHz to 1 GHz	127
1 GHz to 10 GHz	131
10 GHz to 13.5 GHz	132
13.5 GHz to 26.5 GHz	133
26.5 GHz to 30 GHz	124
30 GHz to 35 GHz	123
35 GHz to 40 GHz	121
40 GHz to 50 GHz	119
50 GHz to 60 GHz	118
60 GHz to 67 GHz	119
67 GHz to 70 GHz	117

¹ With an LFE option installed and LFE disabled, applied to frequencies ≤ 100 MHz. Above 100 MHz, performance is the same for both LFE enabled or disabled.

Table 11. Receiver Dynamic Range (dB), All Ports, All LFE Options (LFE Enabled)

Description	Typical
500 Hz to 900 Hz	106
900 Hz to 1 kHz	109
1 kHz to 10 kHz	109
10 kHz to 100 kHz	118
100 kHz to 1 MHz	123
1 MHz to 5 MHz	123
5 MHz to 10 MHz	119
10 MHz to 50 MHz	120
50 MHz to 100 MHz	120

Corrected System Performance, All Options

Applies to the N5227B Option 200, 201, 205, 219, 220, 400, 405, 401, 419, or 420 analyzers, N4697F flexible test port cable set, and a full 2-port calibration. Also applies to the following condition:

Environmental temperature $23^{\circ} \pm 3^{\circ} \text{C}$, with $< 1^{\circ} \text{C}$ deviation from calibration temperature

Note: For any S_{ii} reflection measurement:

- $S_{jj} = 0$.

For any S_{ij} transmission measurement:

- $S_{ji} = S_{ij}$ when $S_{ij} \leq 1$
- $S_{ji} = 1/S_{ij}$ when $S_{ij} > 1$
- $S_{kk} = 0$ for all k

Please download our free Uncertainty Calculator from http://www.keysight.com/find/na_calculator for specifications for other calibration kits and measurement setups.

Table 12. N5227B with 85058B Calibration Kit

Description	Specification (dB)							
	10 MHz to 50 MHz ¹	50 MHz to 2 GHz ¹	2 GHz to 10 GHz	10 GHz to 20 GHz	20 GHz to 35 GHz	35 GHz to 50 GHz	50 GHz to 60 GHz	60 GHz to 67 GHz
Directivity	35	35	38	38	37	37	34	34
Source Match	34	34	40	40	41	42	40	40
Load Match	34	35	37	37	36	36	33	33
Reflection Tracking								
Mag	0.019	0.019	0.033	0.033	0.033	0.020	0.030	0.030
Phase (°)	0.125	0.125	0.218	0.218	0.218	0.132	0.198	0.198
Transmission Tracking								
Mag	0.159	0.128	0.099	0.094	0.100	0.093	0.121	0.137
Phase (°)	1.047	0.845	0.655	0.619	0.663	0.616	0.801	0.903

¹ With an LFE option installed and LFE disabled, applied to frequencies ≤ 100 MHz. Above 100 MHz, performance is the same for both LFE enabled or disabled.

Transmission Uncertainty, All Options

S21 Magnitude Accuracy

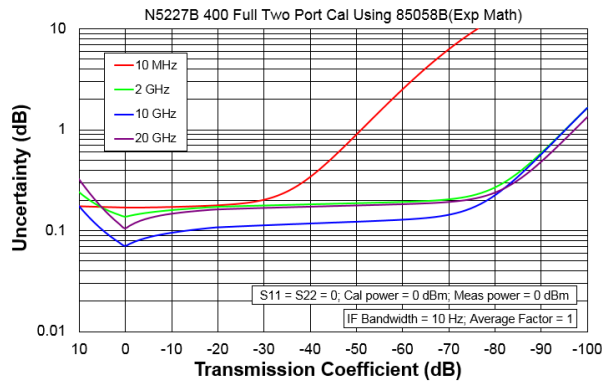

S21 Phase Accuracy

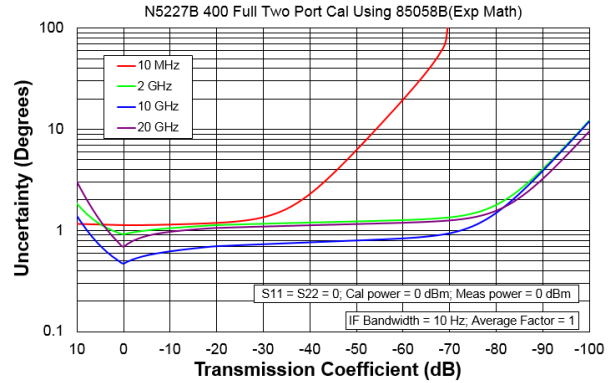

S21 Magnitude Accuracy

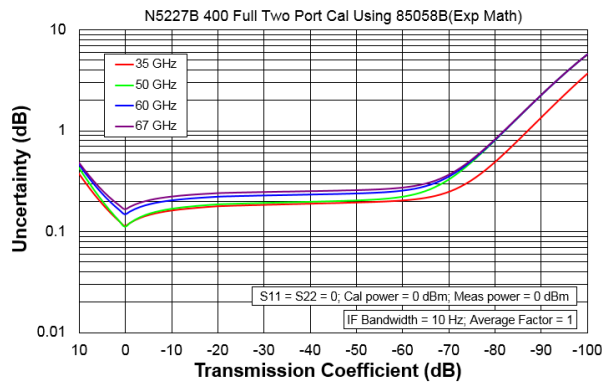

S21 Phase Accuracy

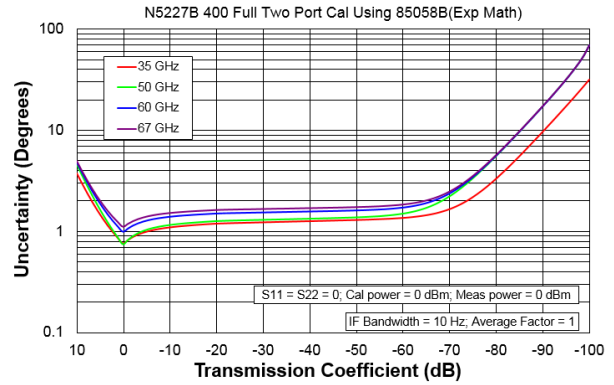

Reflection Uncertainty, All Options

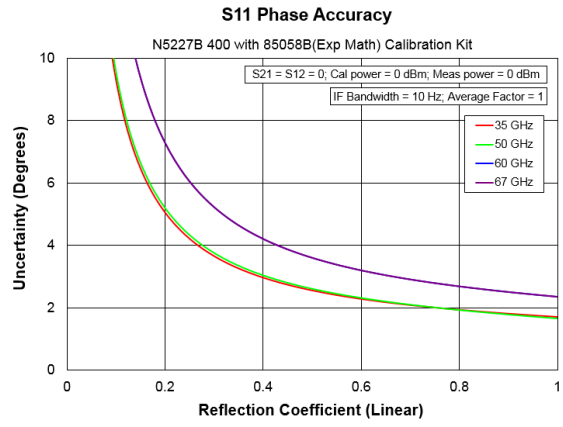
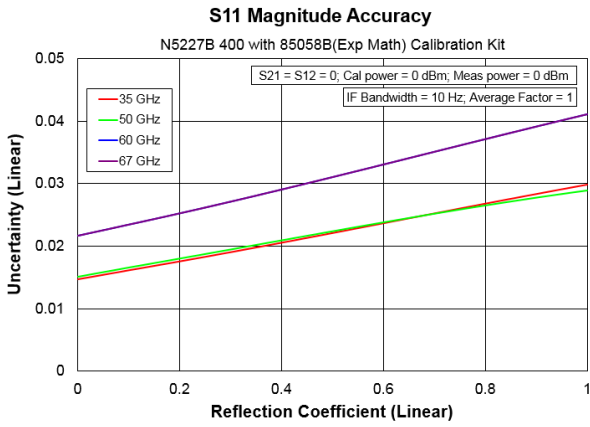
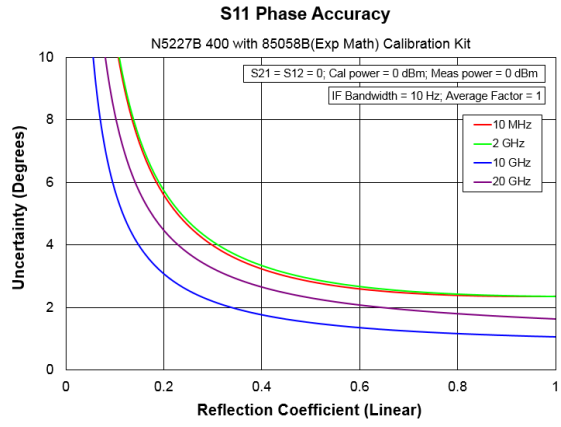
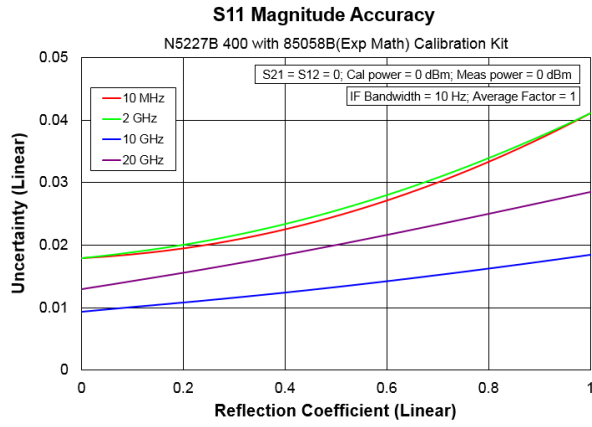

Table 13. N5227B with N4694A 2-Port Electronic Calibration Module

Description	Specification (dB)							
	10 MHz to 50 MHz ¹	50 MHz to 2 GHz ¹	2 GHz to 10 GHz	10 GHz to 20 GHz	20 GHz to 35 GHz	35 GHz to 50 GHz	50 GHz to 60 GHz	60 GHz to 67 GHz
Directivity	33	41	47	46	44	42	41	38
Source Match	25	38	39	35	34	33	30	27
Load Match	25	37	38	34	33	32	29	26
Reflection Tracking								
Mag	±0.050	±0.040	±0.040	±0.050	±0.060	±0.070	±0.080	±0.090
Phase (°)	±0.330	±0.264	±0.264	±0.330	±0.396	±0.462	±0.528	±0.594
Transmission Tracking								
Mag	±0.146	±0.059	±0.057	±0.072	±0.087	±0.104	±0.114	±0.144
Phase (°)	±0.966	±0.392	±0.378	±0.473	±0.576	±0.688	±0.754	±0.951

¹ With Option 205 installed and LFE disabled, applied to frequencies <= 100 MHz. Above 100 MHz, performance is the same for both LFE enabled or disabled.

Transmission Uncertainty, All Options

S21 Magnitude Accuracy

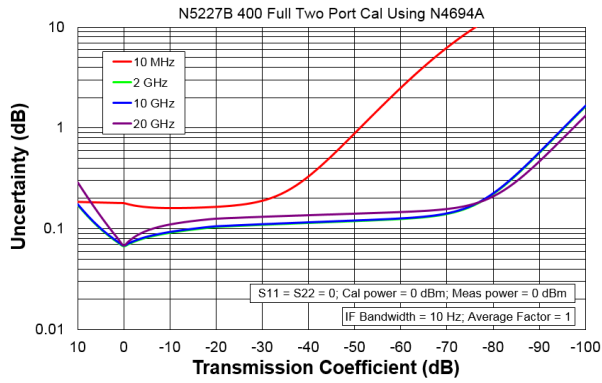

S21 Phase Accuracy

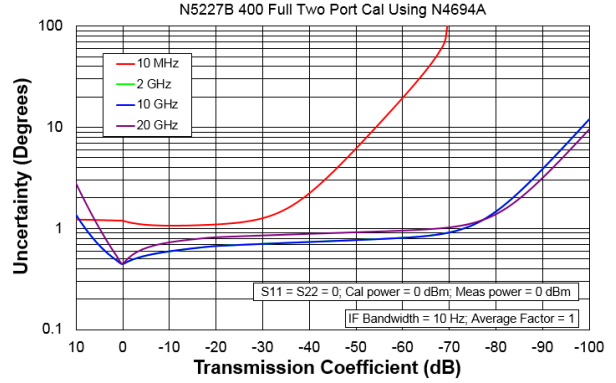

S21 Magnitude Accuracy

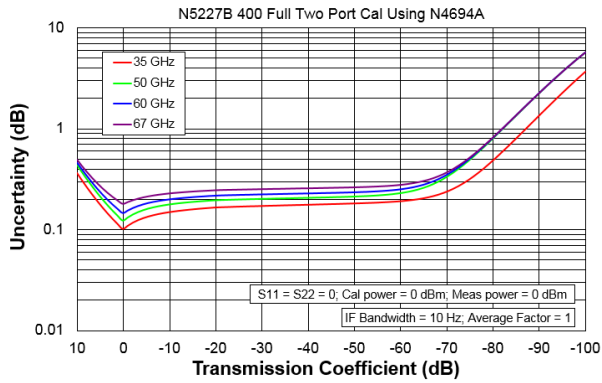

S21 Phase Accuracy

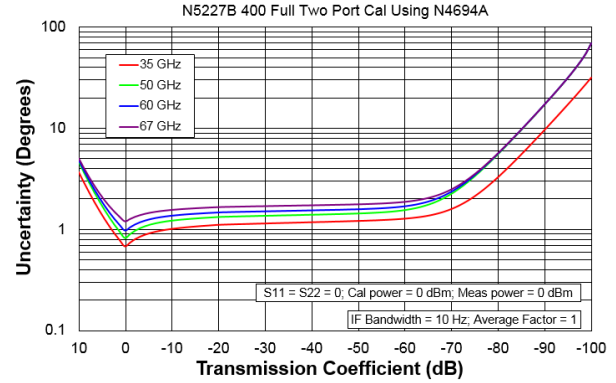

Reflection Uncertainty, All Options

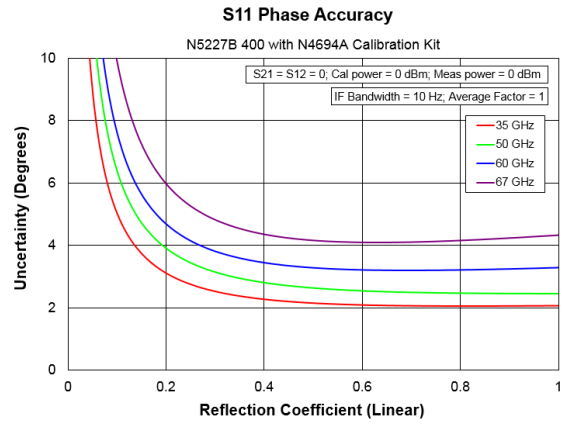
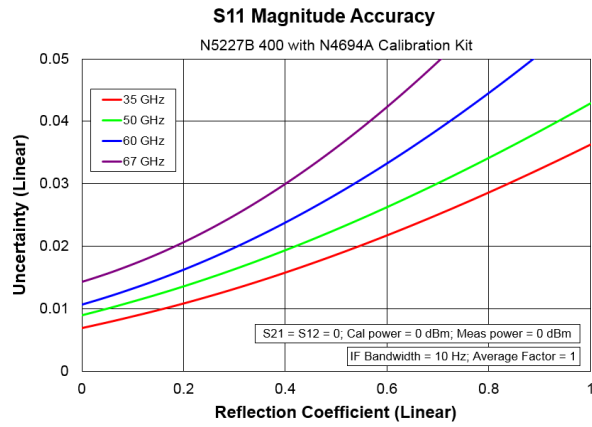
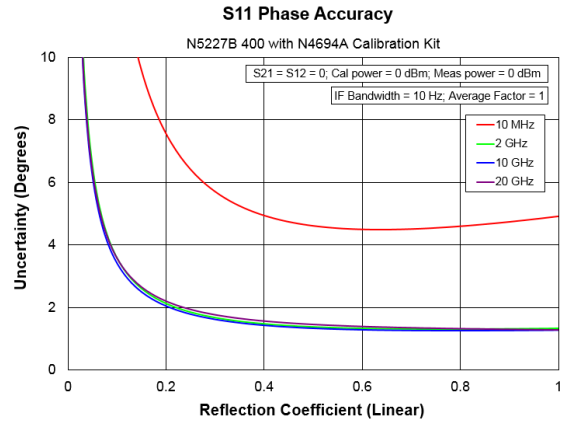
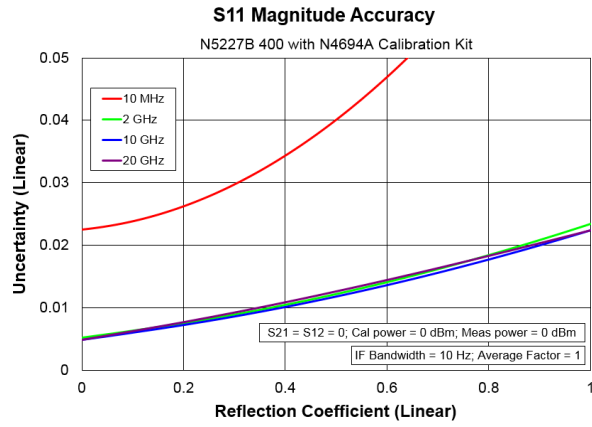

Table 14. N5227B with N4694D 2-Port Electronic Calibration Module

Description	Specification (dB)							
	10 MHz to 50 MHz ¹	50 MHz to 2 GHz ¹	2 GHz to 10 GHz	10 GHz to 20 GHz	20 GHz to 35 GHz	35 GHz to 50 GHz	50 GHz to 60 GHz	60 GHz to 67 GHz
Directivity	41	41	42	41	40	38	35	33
Source Match	38	38	39	35	34	33	30	26
Load Match	35	36	37	33	32	31	28	24
Reflection Tracking								
Mag	±0.081	±0.041	±0.041	±0.051	±0.061	±0.081	±0.081	±0.13
Phase (°)	±0.54	±0.27	±0.27	±0.34	±0.40	±0.54	±0.54	±0.80
Transmission Tracking								
Mag	±0.12	±0.075	±0.075	±0.089	±0.11	±0.14	±0.15	±0.22
Phase (°)	±0.79	±0.50	±0.50	±0.59	±0.69	±0.90	±0.99	±1.5

¹ With an LFE option installed and LFE disabled, applied to frequencies <= 100 MHz. Above 100 MHz, performance is the same for both LFE enabled or disabled.

Transmission Uncertainty, All Options

S21 Magnitude Accuracy

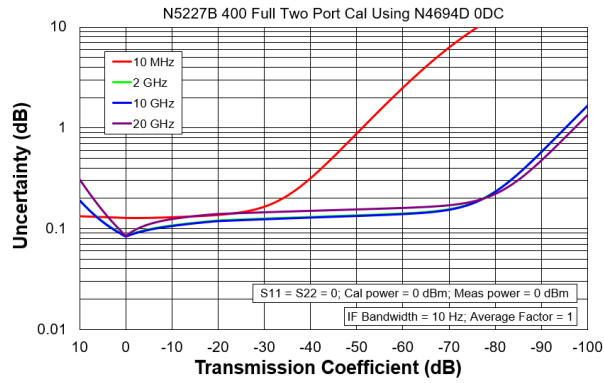

S21 Phase Accuracy

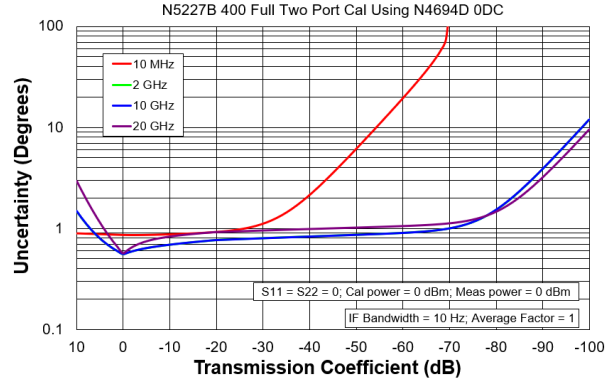

S21 Magnitude Accuracy

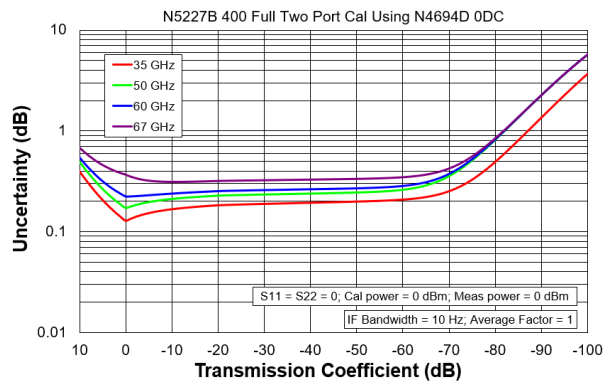

S21 Phase Accuracy

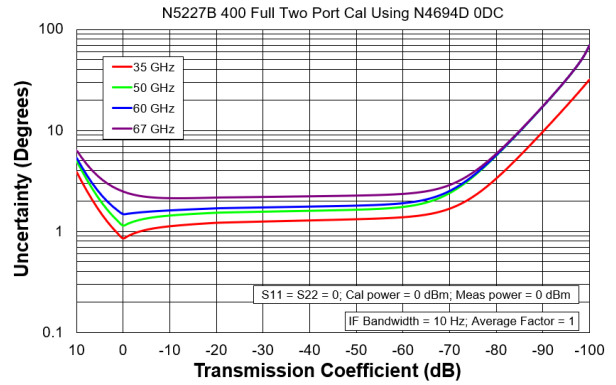

Reflection Uncertainty, All Options

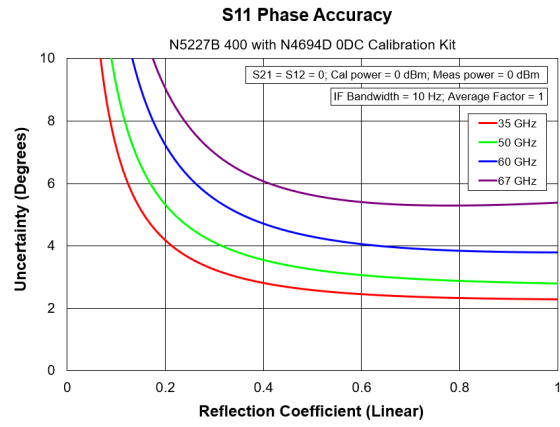
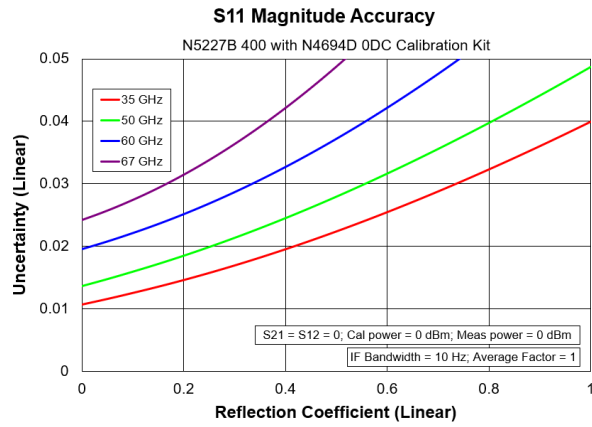
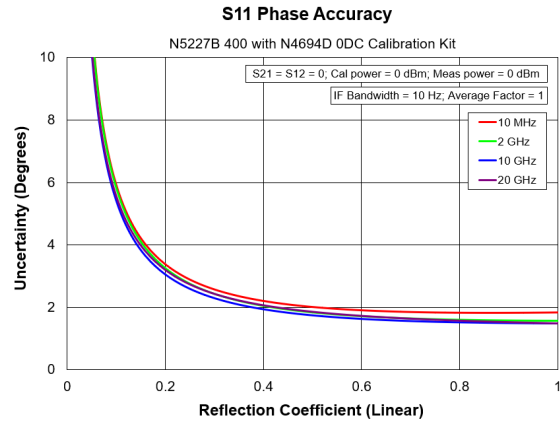
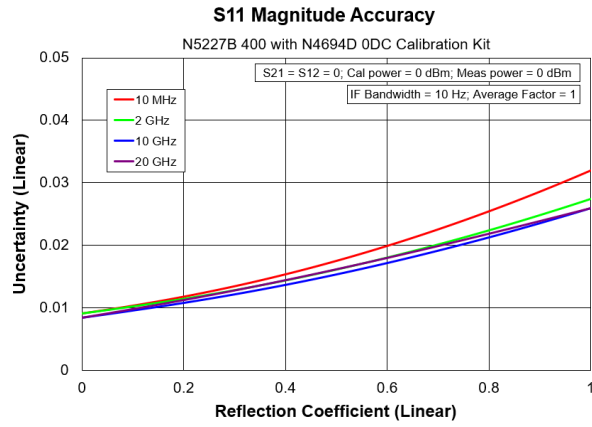
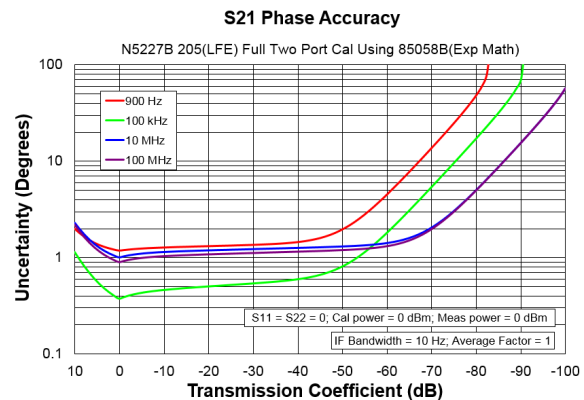
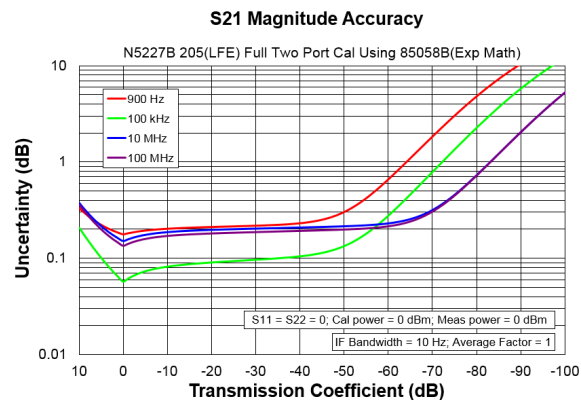

Table 15. N5227B with 85058B Calibration Kit, All LFE Options (LFE Enabled)

Description	Specification (dB)							
	900 Hz to 1 kHz	1 kHz to 10 kHz	10 kHz to 100 kHz	100 kHz to 1 MHz	1 MHz to 5 MHz	5 MHz to 10 MHz	10 MHz to 50 MHz	50 MHz to 100 MHz
Directivity	35	35	35	35	35	35	35	35
Source Match	34	34	34	34	34	34	34	34
Load Match	35	35	35	35	35	35	35	35
Reflection Tracking								
Mag	±0.019	±0.019	±0.019	±0.019	±0.019	±0.019	±0.019	±0.019
Phase (°)	±0.125	±0.125	±0.125	±0.125	±0.125	±0.125	±0.125	±0.125
Transmission Tracking								
Mag	±0.167	±0.149	±0.047	±0.103	±0.140	±0.140	±0.125	±0.125
Phase (°)	±1.105	±0.983	±0.309	±0.680	±0.926	±0.926	±0.823	±0.823

Transmission Uncertainty, All LFE Options

NOTE The plots are valid for all LFE options.



Reflection Uncertainty, All LFE Options

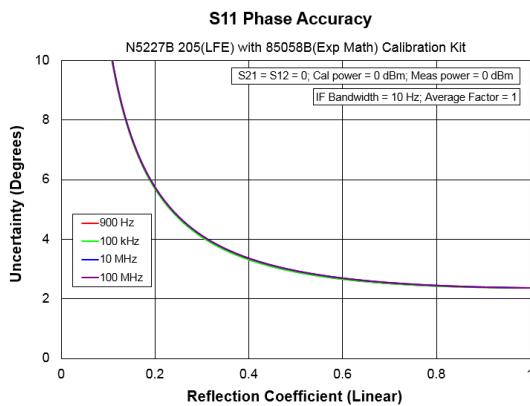
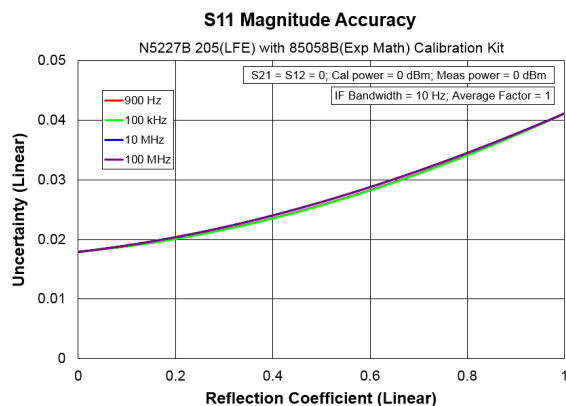
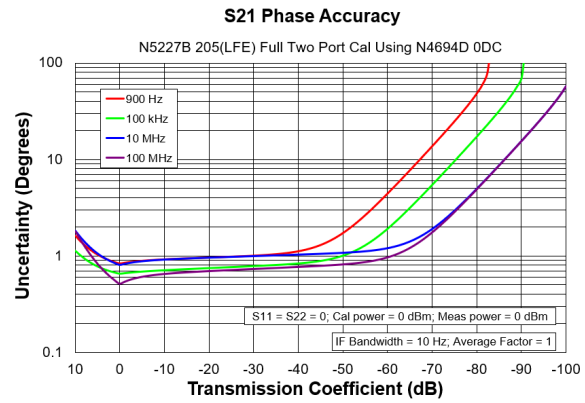
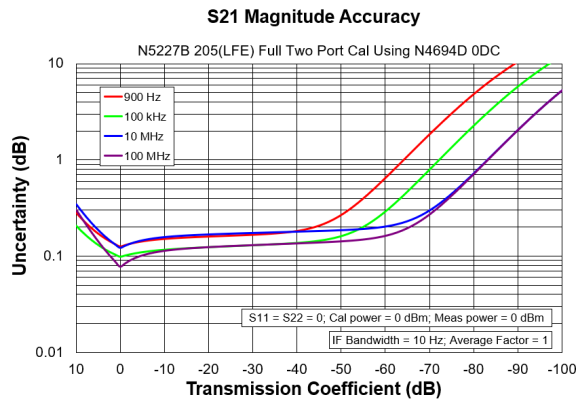

Table 16. N5227B with N4694D Calibration Kit, All LFE Options (LFE Enabled)

Description	Specification (dB)							
	900 Hz to 1 kHz	1 kHz to 10 kHz	10 kHz to 100 kHz	100 kHz to 1 MHz	1 MHz to 5 MHz	5 MHz to 10 MHz	10 MHz to 50 MHz	50 MHz to 100 MHz
Directivity	41	41	41	41	41	41	41	41
Source Match	38	38	38	38	38	38	38	38
Load Match	35	35	37	37	36	35	35	36
Reflection Tracking								
Mag	±0.081	±0.081	±0.081	±0.081	±0.081	±0.081	±0.081	±0.041
Phase (°)	±0.54	±0.54	±0.54	±0.54	±0.54	±0.54	±0.54	±0.27
Transmission Tracking								
Mag	±0.12	±0.12	±0.089	±0.089	±0.11	±0.12	±0.12	±0.068
Phase (°)	±0.76	±0.76	±0.59	±0.59	±0.68	±0.74	±0.74	±0.45

Transmission Uncertainty, All LFE Options

NOTE The plots are valid for all LFE options.



Reflection Uncertainty, All LFE Options

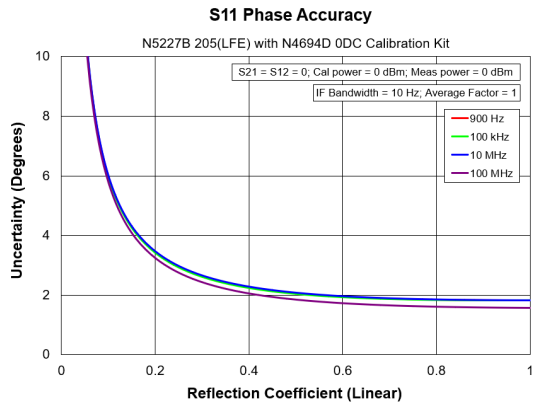
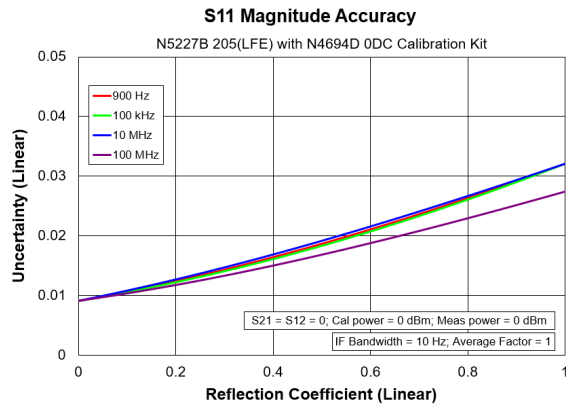

Uncorrected System Performance

Specifications apply to following conditions:

- Cable loss not included in Transmission Tracking.
- Crosstalk measurement conditions: normalized to a thru, measured with shorts on all ports, 10 Hz IF bandwidth, averaging factor of 8, alternate mode, source power set to the specified maximum power.

Table 17. Error Terms (dB), All Ports, All Options - Specifications

Description	Directivity	Source Match	Load Match	Transmission Tracking	Reflection Tracking	Crosstalk
10 MHz to 50 MHz ¹	17 (17)	7 (6) [7]	6 (6)	--	--	--
50 MHz to 500 MHz ¹	24 (24)	15 (7) [6]	11 (7)	--	--	--
500 MHz to 2 GHz	24 (24)	10 (7) [6]	7 (7)	--	--	--
2 GHz to 3.2 GHz	20 (20)	10 (7) [8]	7 (7)	--	--	--
3.2 GHz to 10 GHz	20 (20)	7 (7) [7]	7 (7)	--	--	--
10 GHz to 16 GHz	16 (16)	7 (6) [7]	6 (6)	--	--	--
16 GHz to 20 GHz	16 (16)	7 (7) [7]	7 (7)	--	--	--
20 GHz to 26.5 GHz	14 (14)	7 (7) [7]	7 (7)	--	--	--
26.5 GHz to 50 GHz	13 (11)	7 (6) [7]	6 (6)	--	--	--
50 GHz to 60 GHz	13 (13)	7 (7) [6]	7 (7)	--	--	--
60 GHz to 67 GHz	10 (10)	6 (6) [5]	6 (6)	--	--	--
67 GHz to 70 GHz	--	--	--	--	--	--

() With an LFE option installed except for Source Match.

[] With option 220, 420 for Source Match only.

¹ With an LFE option installed and LFE disabled, applied to frequencies <= 100 MHz. Above 100 MHz, performance is the same for both LFE enabled or disabled. For LFE enabled performance <= 100 MHz, see Table 18.

Table 18. Error Terms (dB), All Ports, All LFE Options (LFE Enabled) - Specifications

Description	Directivity	Source Match	Load Match	Transmission Tracking	Reflection Tracking	Crosstalk
1 kHz to 10 kHz	1	7	7	--	--	--
10 kHz to 1 MHz	16	15	19	--	--	--
1 MHz to 5 MHz	16	9	11	--	--	--
5 MHz to 50 MHz	5	7	8	--	--	--
50 MHz to 100 MHz	5	8	9	--	--	--

Table 19. Error Terms (dB), All Ports, All Options - Typical

Description	Directivity	Source Match	Load Match	Transmission Tracking	Reflection Tracking	Crosstalk
10 MHz to 50 MHz ¹	20 (20)	9 (9)	8 (8)	±1.0	±1.0	-88 (-81)
50 MHz to 200 MHz ¹	28 (28)	19 (10)	17 (10)	±1.0	±1.0	-112 (-107)
200 MHz to 500 MHz	28 (28)	19 (8)	17 (8)	±1.0	±1.0	-129 (-121)
500 MHz to 2 GHz	31 (31)	14 (9)	12 (8)	±1.0	±1.0	-131 (-128)
2 GHz to 3.2 GHz	28 (28)	14 (13)	12 (12)	±1.0	±1.0	-127 (-124)
3.2 GHz to 10 GHz	25 (25)	11 (11)	10 (10)	±1.0	±1.0	-127 (-125)
10 GHz to 13.5 GHz	23 (23)	10 (10)	10 (10)	±1.0	±1.0	-127 (-125)
13.5 GHz to 16 GHz	23 (23)	11 (11)	11 (11)	±1.0	±1.0	-127 (-125)
16 GHz to 20 GHz	20 (20)	11 (11)	11 (11)	±1.0	±1.0	-127 (-125)
20 GHz to 26.5 GHz	18 (18)	11 (11)	11 (11)	±1.0	±1.0	-126 (-124)
26.5 GHz to 43.5 GHz	16 (16)	11 (11)	11 (11)	±1.0	±1.0	-112 (-111)
43.5 GHz to 50 GHz	19 (16)	11 (11)	11 (11)	±1.0	±1.0	-115 (-114)
50 GHz to 60 GHz	16 (16)	11 (11)	12 (12)	±1.0	±1.0	-111 (-110)
60 GHz to 67 GHz	16 (16)	9 (9)	10 (10)	±1.0	±1.0	-112 (-111)
67 GHz to 70 GHz	15 (15)	10 (10)	10 (10)	±1.0	±1.5	-109 (-108)

() With an LFE option installed.

¹ With an LFE option installed and LFE disabled, applied to frequencies <= 100 MHz. Above 100 MHz, performance is the same for both LFE enabled or disabled. For LFE enabled performance <= 100 MHz, see Table 20.

Table 20. Error Terms (dB), All Ports, All LFE Options (LFE Enabled) - Typical

Description	Directivity	Source Match	Load Match	Transmission Tracking	Reflection Tracking	Crosstalk
500 Hz to 900 Hz	--	--	--	--	--	-102
900 Hz to 1 kHz	4	8	9	±1.5	±1.5	-106
1 kHz to 10 kHz	5	9	8	±1.5	±1.5	-100
10 kHz to 100 kHz	23	19	23	±1.5	±1.5	-106
100 kHz to 1 MHz	23	19	23	±1.5	±1.5	-126
1 MHz to 5 MHz	26	13	14	±1.5	±1.5	-121
5 MHz to 10 MHz	11	9	10	±1.5	±1.5	-121
10 MHz to 50 MHz	11	9	10	±1.5	±1.5	-117
50 MHz to 100 MHz	11	11	11	±1.5	±1.5	-117

Test Port Output

See the block diagrams at the end of this document for all models and options.

Table 21. Frequency Information, All Options

Description	Specification	Typical
N5227B Frequency Range	10 MHz to 67 GHz	67 GHz to 70 GHz
N5227B Frequency Range (LFE Options)	900 Hz to 67 GHz	500 Hz to 900 Hz
Frequency Resolution	1 Hz	--
Frequency Accuracy	±0.7 ppm	--
Initial Frequency Accuracy ¹	±0.2 ppm	±0.1 ppm
Frequency Stability	--	±0.05 ppm, -10° to 70° C ² ±0.5 (first year) ³ ±0.1 ppm/yr maximum ²

¹ Verified after Factory Frequency Reference adjustment, or after adjustment at a Keysight Service Center.

² Assumes no variation in time.

³ Assumes no variation in temperature. Stability generally improves over time.

Table 22. Maximum Levelled Power (dBm), All Ports - Specification

Description	Option 200, 400		Option 201, 401		Option 219, 419	
	Port 1, Port 3	Port 2, Port 4	Port 1, Port 3	Port 2, Port 4	Port 1, Port 3	Port 2, Port 4
10 MHz to 50 MHz	10	10	10	10	9	9
50 MHz to 2 GHz	13	13	13	13	13	13
2 GHz to 3.2 GHz	10	13	10	13	9	13
3.2 GHz to 10 GHz	13	13	13	13	11	12
10 GHz to 13.5 GHz	12	12	11	11	9	9
13.5 GHz to 16 GHz	12	12	12	12	10	10
16 GHz to 19 GHz	11	11	10	10	8	8
19 GHz to 24 GHz	11	11	11	11	8	8
24 GHz to 26.5 GHz	11	11	11	11	7	7
26.5 GHz to 30 GHz	10	10	10	10	7	7
30 GHz to 32 GHz	9	9	7	7	5	5
32 GHz to 35 GHz	10	10	9	9	6	6
35 GHz to 40 GHz	5	5	5	5	1	1
40 GHz to 50 GHz	11	11	10	10	6	6
50 GHz to 64 GHz	11	11	10	10	5	5
64 GHz to 67 GHz	11	11	10	10	4	4

Table 23. Maximum Leveled Power (dBm), All Ports - Typical

Description	Option 200, 400		Option 201, 401		Option 219, 419	
	Port 1, Port 3	Port 2, Port 4	Port 1, Port 3	Port 2, Port 4	Port 1, Port 3	Port 2, Port 4
10 MHz to 50 MHz	20	17	19	17	19	17
50 MHz to 500 MHz	20	18	20	18	19	17
500 MHz to 1 GHz	20	21	20	20	19	18
1 GHz to 2 GHz	18	20	18	20	17	18
2 GHz to 3.2 GHz	17	18	17	17	15	17
3.2 GHz to 10 GHz	19	19	19	18	18	18
10 GHz to 13.5 GHz	18	16	17	15	16	14
13.5 GHz to 16 GHz	19	18	18	17	17	16
16 GHz to 19 GHz	17	17	17	16	14	14
19 GHz to 20 GHz	17	17	17	16	13	13
20 GHz to 24 GHz	16	16	16	15	12	13
24 GHz to 30 GHz	15	15	15	14	12	12
30 GHz to 32 GHz	14	14	13	13	11	11
32 GHz to 35 GHz	15	15	14	14	12	12
35 GHz to 40 GHz	13	13	12	11	9	9
40 GHz to 43.5 GHz	12	12	11	12	11	10
43.5 GHz to 50 GHz	12	13	11	12	10	10
50 GHz to 60 GHz	12	13	12	12	10	9
60 GHz to 64 GHz	12	13	12	12	9	9
64 GHz to 67 GHz	13	14	13	13	8	8
67 GHz to 70 GHz	13	14	12	12	4	4

Table 24. Maximum Leveled Power (dBm) – All LFE Options - Specification

Description	Option 205, 405		Option 220, 420	
	Port 1, Port 3	Port 2, Port 4	Port 1, Port 3	Port 2, Port 4
10 MHz to 50 MHz ¹	3	3	2	2
50 MHz to 2 GHz ¹	8	8	9	9
2 GHz to 3.2 GHz	9	9	6	10
3.2 GHz to 10 GHz	9	9	9	10
10 GHz to 13.5 GHz	9	9	7	7
13.5 GHz to 16 GHz	9	10	8	8
16 GHz to 19 GHz	8	8	6	6
19 GHz to 24 GHz	9	9	6	6
24 GHz to 26.5 GHz	7	7	5	5
26.5 GHz to 30 GHz	8	8	6	6
30 GHz to 32 GHz	8	8	4	4
32 GHz to 35 GHz	7	7	5	5
35 GHz to 40 GHz	3	3	0	0
40 GHz to 50 GHz	6	6	5	5
50 GHz to 64 GHz	3	3	4	4
64 GHz to 67 GHz	7	7	3	3

¹ With an LFE option installed and LFE disabled, applied to frequencies ≤ 100 MHz. Above 100 MHz, performance is the same for both LFE enabled or disabled. For LFE enabled performance ≤ 100 MHz, see Table 26.

Table 25. Maximum Levelled Power (dBm) – All LFE Options - Typical

Description	Option 205, 405		Option 220, 420	
	Port 1, Port 3	Port 2, Port 4	Port 1, Port 3	Port 2, Port 4
10 MHz to 50 MHz ¹	12	10	12	10
50 MHz to 500 MHz ¹	15	13	15	13
500 MHz to 1 GHz	16	16	16	15
1 GHz to 2 GHz	14	16	14	15
2 GHz to 3.2 GHz	16	15	12	14
3.2 GHz to 10 GHz	15	15	16	16
10 GHz to 13.5 GHz	14	12	14	12
13.5 GHz to 16 GHz	15	14	15	14
16 GHz to 19 GHz	14	13	12	12
19 GHz to 20 GHz	13	12	11	11
20 GHz to 24 GHz	13	12	10	11
24 GHz to 30 GHz	12	11	10	10
30 GHz to 32 GHz	11	11	10	10
32 GHz to 35 GHz	11	11	11	11
35 GHz to 40 GHz	10	9	8	8
40 GHz to 43.5 GHz	9	10	10	9
43.5 GHz to 50 GHz	9	10	9	9
50 GHz to 60 GHz	9	9	9	8
60 GHz to 64 GHz	9	9	8	8
64 GHz to 67 GHz	9	9	7	7
67 GHz to 70 GHz	--	--	3	3

¹ With an LFE option installed and LFE disabled, applied to frequencies <= 100 MHz. Above 100 MHz, performance is the same for both LFE enabled or disabled. For LFE enabled performance <= 100 MHz, see Table 26.

Table 26. Maximum Power (dBm), All Ports – All LFE Options (LFE Enabled)

Description	Specification	Typical ¹
500 Hz to 900 Hz	--	12
900 Hz to 1 kHz	10	13
1 kHz to 10 kHz	12	13
10 kHz to 100 kHz	12	14
100 kHz to 1 MHz	12	14
1 MHz to 5 MHz	10	13
5 MHz to 10 MHz	9	11
10 MHz to 50 MHz	8	10
50 MHz to 100 MHz	8	10

¹ Values apply to all ports. Ports 2 and 4 typically 1 dB higher.

Table 27. Power Level Accuracy (dB) at Nominal Power¹, All Options

Description	Specification	Typical
10 MHz to 50 MHz ²	±1.8	±0.4
50 MHz to 1 GHz ²	±1.0	±0.4
1 GHz to 3.2 GHz	±1.0	±0.2
3.2 GHz to 20 GHz	±2.0	±0.4
20 GHz to 26.5 GHz	±2.2	±0.4
26.5 GHz to 40 GHz	±3.0	±0.5
40 GHz to 43.5 GHz	±3.0	±0.3
43.5 GHz to 50 GHz	±3.0	±0.5
50 GHz to 60 GHz	±3.5	±0.6
60 GHz to 67 GHz	±4.0	±0.7
67 GHz to 70 GHz	--	±1.0

¹ Level accuracy at power other than nominal power, Power Level Accuracy (dB) at Nominal Power + Power Level Linearity (dB).

² With an LFE option installed and LFE disabled, applied to frequencies ≤ 100 MHz. Above 100 MHz, performance is the same for both LFE enabled or disabled. For LFE enabled performance ≤ 100 MHz, see Table 28.

Table 28. Power Level Accuracy (dB), All Ports, All LFE Options (LFE Enabled)

Description	Specification	Typical ¹
500 Hz to 900 Hz	--	± 0.1
900 Hz to 1 kHz	± 1.0	± 0.1
1 kHz to 10 kHz	± 1.0	± 0.1
10 kHz to 100 kHz	± 1.0	± 0.1
100 kHz to 1 MHz	± 1.0	± 0.15
1 MHz to 5 MHz	± 1.0	± 0.15
5 MHz to 10 MHz	± 1.0	± 0.2
10 MHz to 50 MHz	± 1.0	± 0.2
50 MHz to 100 MHz	± 1.0	± 0.2

Table 29. Power Level Linearity¹ (dB), All Options - Specification

Description	Ports 1, 3 ² -25 dBm ≤ P < -20 dBm	Ports 1, 3 ² -20 dBm ≤ P < -15 dBm	Ports 1, 3 ² P ≥ -15 dBm
10 MHz to 50 MHz ³	±2.7	±1.7	±1.5
50 MHz to 500 MHz ³	±1.7	±1.5	±1.5
500 MHz to 67 GHz ³	±1.5	±1.5	±1.5

¹ Referenced to nominal power.

² Either port can be used as the source port.

³ With an LFE option installed and LFE disabled, applied to frequencies ≤ 100 MHz. Above 100 MHz, performance is the same for both LFE enabled or disabled. For LFE enabled performance ≤ 100 MHz, see Table 31.

Table 30. Power Level Linearity¹ (dB), All Options - Specification

Description	Ports 2, 4 ² -25 dBm ≤ P < -20 dBm	Ports 2, 4 ² -20 dBm ≤ P < -15 dBm	Ports 2, 4 ² P ≥ -15 dBm
10 MHz to 50 MHz ³	±3.5	±1.7	±1.5
50 MHz to 500 MHz ³	±2.7	±1.5	±1.5
500 MHz to 3.2 GHz	±2.5	±1.5	±1.5
3.2 GHz to 67 GHz	±1.5	±1.5	±1.5

¹ Referenced to nominal power.

² Either port can be used as the source port.

³ With an LFE option installed and LFE disabled, applied to frequencies ≤ 100 MHz. Above 100 MHz, performance is the same for both LFE enabled or disabled. For LFE enabled performance ≤ 100 MHz, see Table 31.

Table 31. Power Level Linearity¹ (dB), All Ports, All LFE Options (LFE Enabled)

Description	Specification
500 Hz to 900 Hz	--
900 Hz to 100 MHz	±1.0

¹ Referenced to nominal power, from -25 dBm to max power.

Table 32. Power Sweep Range (dB), All Ports - Specification

Description	Option 200, 400		Option 201, 401		Option 219, 419	
	Port 1, Port 3	Port 2, Port 4	Port 1, Port 3	Port 2, Port 4	Port 1, Port 3	Port 2, Port 4
10 MHz to 50 MHz	37	37	37	37	36	36
50 MHz to 2 GHz	38	38	38	38	38	38
2 GHz to 3.2 GHz	35	38	35	38	34	38
3.2 GHz to 10 GHz	38	38	38	38	36	37
10 GHz to 13.5 GHz	37	37	36	36	34	34
13.5 GHz to 16 GHz	37	37	37	37	35	35
16 GHz to 19 GHz	36	36	35	35	33	33
19 GHz to 24 GHz	36	36	36	36	33	33
24 GHz to 26.5 GHz	36	36	36	36	32	32
26.5 GHz to 30 GHz	35	35	35	35	32	32
30 GHz to 32 GHz	34	34	32	32	30	30
32 GHz to 35 GHz	35	35	34	34	31	31
35 GHz to 40 GHz	30	30	30	30	26	26
40 GHz to 50 GHz	36	36	35	35	31	31
50 GHz to 64 GHz	36	36	35	35	30	30
64 GHz to 67 GHz	36	36	35	35	29	29

Table 33. Power Sweep Range (dB), All Ports - Typical

Description	Option 200, 400		Option 201, 401		Option 219, 419	
	Port 1, Port 3	Port 2, Port 4	Port 1, Port 3	Port 2, Port 4	Port 1, Port 3	Port 2, Port 4
10 MHz to 50 MHz	47	44	46	44	46	44
50 MHz to 500 MHz	47	45	47	45	46	44
500 MHz to 1 GHz	47	48	47	47	46	45
1 GHz to 2 GHz	45	47	45	47	44	45
2 GHz to 3.2 GHz	44	45	44	44	42	44
3.2 GHz to 10 GHz	46	46	46	45	45	45
10 GHz to 13.5 GHz	45	43	44	42	43	41
13.5 GHz to 16 GHz	46	45	45	44	44	43
16 GHz to 19 GHz	44	44	44	43	41	41
19 GHz to 20 GHz	44	44	44	43	40	40
20 GHz to 24 GHz	43	43	43	42	39	40
24 GHz to 30 GHz	42	42	42	41	39	39
30 GHz to 32 GHz	41	41	40	40	38	38
32 GHz to 35 GHz	42	42	41	41	39	39
35 GHz to 40 GHz	40	40	39	38	36	36
40 GHz to 43.5 GHz	39	39	38	39	38	37
43.5 GHz to 50 GHz	39	40	38	39	37	37
50 GHz to 60 GHz	39	40	39	39	37	36
60 GHz to 64 GHz	39	40	39	39	36	36
64 GHz to 67 GHz	40	41	40	40	35	35
67 GHz to 70 GHz	40	41	39	39	31	31

Table 34. Power Sweep Range (dB) – All LFE Options - Specification

Description	Option 205, 405		Option 220, 420	
	Port 1, Port 3	Port 2, Port 4	Port 1, Port 3	Port 2, Port 4
10 MHz to 50 MHz ¹	28	28	29	29
50 MHz to 2 GHz ¹	33	33	34	34
2 GHz to 3.2 GHz	34	34	31	35
3.2 GHz to 10 GHz	34	34	34	35
10 GHz to 13.5 GHz	34	36	32	32
13.5 GHz to 16 GHz	34	35	33	33
16 GHz to 19 GHz	33	33	31	31
19 GHz to 24 GHz	34	34	31	31
24 GHz to 26.5 GHz	32	32	30	30
26.5 GHz to 30 GHz	32	32	31	31
30 GHz to 32 GHz	32	32	29	29
32 GHz to 35 GHz	32	32	30	30
35 GHz to 40 GHz	30	30	25	25
40 GHz to 50 GHz	31	31	30	30
50 GHz to 64 GHz	28	28	29	29
64 GHz to 67 GHz	33	33	28	28

¹ With an LFE option installed and LFE disabled, applied to frequencies ≤ 100 MHz. Above 100 MHz, performance is the same for both LFE enabled or disabled. For LFE enabled performance ≤ 100 MHz, see Table 36.

Table 35. Power Sweep Range (dB) – All LFE Options - Typical

Description	Option 205, 405		Option 220, 420	
	Port 1, Port 3	Port 2, Port 4	Port 1, Port 3	Port 2, Port 4
10 MHz to 50 MHz ¹	39	37	39	37
50 MHz to 500 MHz ¹	42	40	42	40
500 MHz to 1 GHz	43	43	43	42
1 GHz to 2 GHz	43	43	41	42
2 GHz to 3.2 GHz	43	43	39	41
3.2 GHz to 10 GHz	41	43	43	43
10 GHz to 13.5 GHz	43	42	41	39
13.5 GHz to 16 GHz	42	42	42	41
16 GHz to 19 GHz	41	39	39	39
19 GHz to 20 GHz	41	39	38	38
20 GHz to 24 GHz	42	41	37	38
24 GHz to 30 GHz	40	39	37	37
30 GHz to 32 GHz	39	38	37	37
32 GHz to 35 GHz	39	38	38	38
35 GHz to 40 GHz	38	38	35	35
40 GHz to 43.5 GHz	38	38	37	36
43.5 GHz to 50 GHz	38	38	36	36
50 GHz to 60 GHz	37	36	36	35
60 GHz to 64 GHz	37	36	35	35
64 GHz to 67 GHz	36	37	34	34
67 GHz to 70 GHz	--	--	30	30

¹ With an LFE option installed and LFE disabled, applied to frequencies ≤ 100 MHz. Above 100 MHz, performance is the same for both LFE enabled or disabled. For LFE enabled performance ≤ 100 MHz, see Table 36.

Table 36. Power Sweep Range (dB) – All LFE Options (LFE Enabled)

Description	Specification	Typical
500 Hz to 900 Hz	--	39
900 Hz to 1 kHz	35	40
1 kHz to 10 kHz	37	40
10 kHz to 100 kHz	37	41
100 kHz to 1 MHz	37	41
1 MHz to 5 MHz	35	40
5 MHz to 10 MHz	34	38
10 MHz to 50 MHz	33	37
50 MHz to 100 MHz	33	37

Table 37. Nominal Power (Preset Power, dBm)

Description	Option 200, 201, 205, 400, 401, 405	Option 219, 220, 419, 420
Preset Power	0	-5

Table 38. Power Resolution and Maximum/Minimum Settable Power, All Models and Options

Description	Specification (dB)	Typical (dBm)
Power Resolution	0.01	--
Maximum Settable Power	--	30
Minimum Settable Power		
Option 200, 201, 205, 400, 401, 405	--	-30
Option 219, 220, 419, 420	--	-80

Table 39. 2nd and 3rd Harmonics at Max Specified Power (dBc), All Options - Typical

Listed frequency is fundamental frequency; test at max specified power.

Description	2nd Harmonic	3rd Harmonic
10 MHz to 50 MHz ¹	-18	-16
50 MHz to 3.3 GHz ¹	-25	-15
3.3 GHz to 13.5 GHz	-17	-19
13.5 GHz to 23.4 GHz	-60	-65
23.4 GHz to 35 GHz	-60	--

¹ With an LFE option installed and LFE disabled, applied to frequencies ≤ 100 MHz. Above 100 MHz, performance is the same for both LFE enabled or disabled. For LFE enabled performance ≤ 100 MHz, see Table 40.

Table 40. 2nd and 3rd Harmonics at Max Specified Power (dBc), All Ports, All LFE Options (LFE Enabled) - Typical

Listed frequency is fundamental frequency; test at max specified power.

Description	2nd Harmonic	3rd Harmonic
500 Hz to 900 Hz	-32	-31
900 Hz to 1 kHz	-22	-23
1 kHz to 10 kHz	-22	-23
10 kHz to 100 kHz	-22	-23
100 kHz to 1 MHz	-25	-22
1 MHz to 5 MHz	-28	-24
5 MHz to 10 MHz	-27	-22
10 MHz to 33 MHz	-28	-21
33 MHz to 50 MHz	-28	--

Table 41. Non-Harmonic Spurs¹ at Nominal Power (dBc), All Models and Options – Typical

Listed frequency is Source CW frequency, tested at 0 dBm.

Description	Non-Harmonic	±600 MHz Tracking Spur
10 MHz to 1 GHz	-80	-80
1 GHz to 10 GHz	-85	-81
10 GHz to 20 GHz	-82	-75
20 GHz to 31 GHz	-80	-70
31 GHz to 50 GHz	-77	-67
50 GHz to 67 GHz	-76	-62

¹ Non-harmonic spurs are negligible with Option 425 installed and LFE enabled.

Tracking Spurs (Linear Frequency Scale)

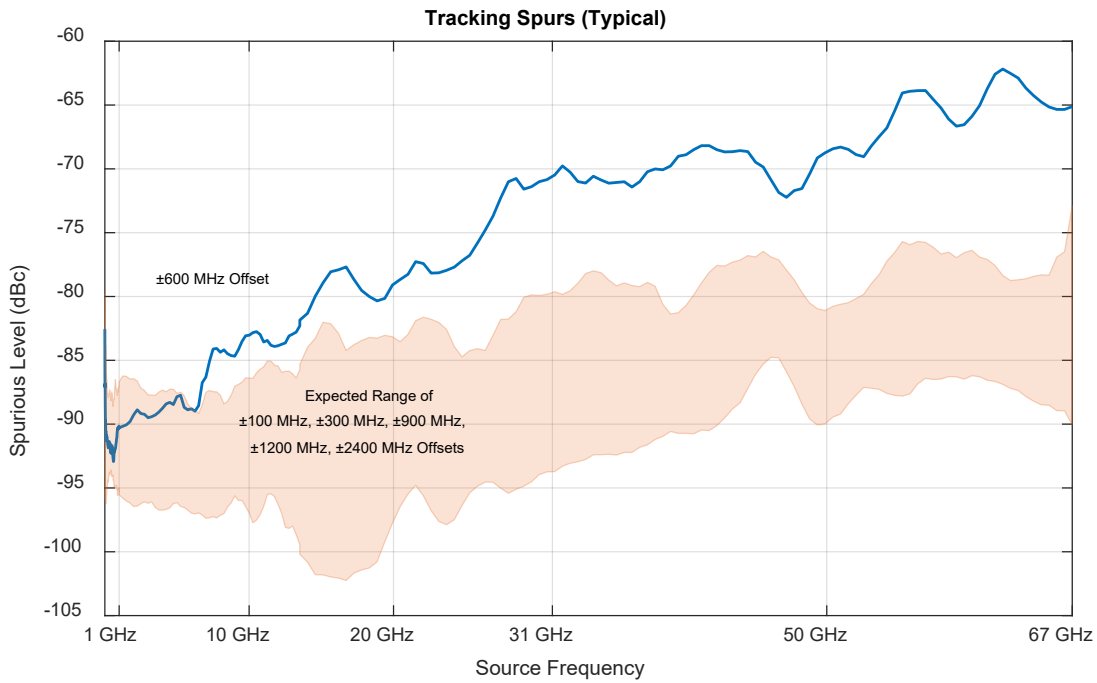

Tracking Spurs (Logarithmic Frequency Scale)

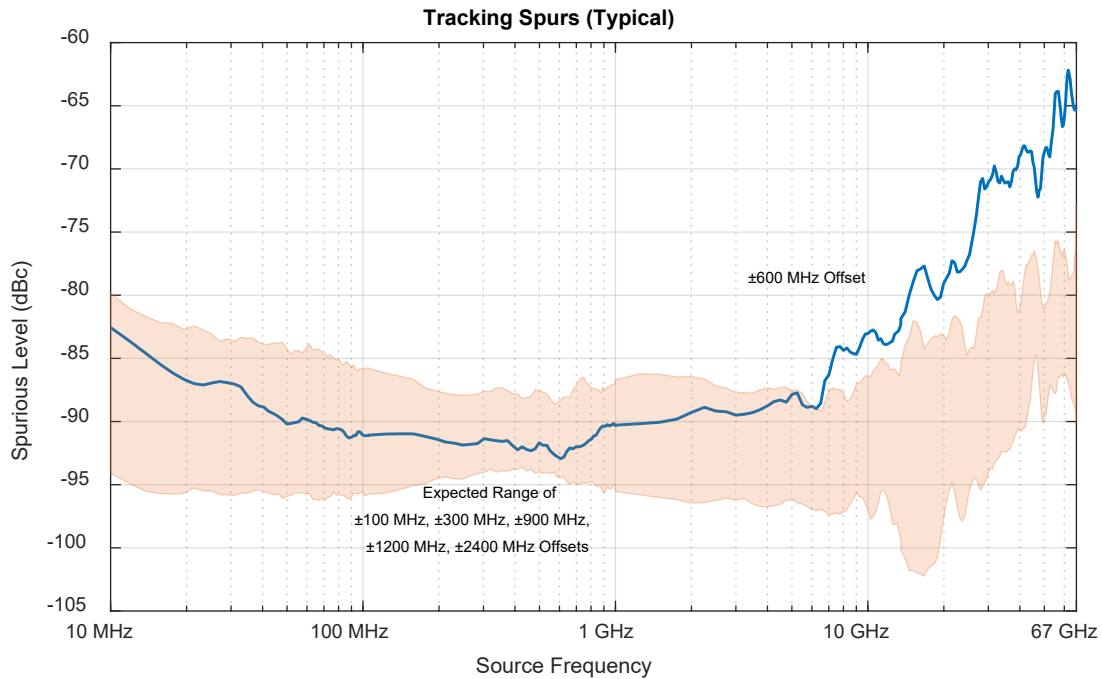

Table 42. Phase Noise (dBc/Hz), All Options, with UNY, Port 1, 3 - Typical

CW Frequency	100 Hz Offset	1 kHz Offset	10 kHz Offset	100 kHz Offset	1 MHz Offset	10 MHz Offset
1 GHz	-112	-132	-137	-143	-145	-144
5 GHz	-103	-123	-132	-135	-147	-150
10 GHz	-96	-116	-126	-130	-142	-146
20 GHz	-91	-111	-118	-123	-135	-139
26.5 GHz	-87	-106	-115	-121	-131	-135

Table 43. Phase Noise (dBc/Hz), All Options, with UNY, Port 2, 4 - Typical

CW Frequency	100 Hz Offset	1 kHz Offset	10 kHz Offset	100 kHz Offset	1 MHz Offset	10 MHz Offset
1 GHz	-111	-121	-132	-145	-149	-149
5 GHz	-103	-122	-128	-134	-145	-149
10 GHz	-96	-112	-120	-127	-140	-147
20 GHz	-90	-108	-116	-123	-134	-139
26.5 GHz	-86	-106	-114	-121	-131	-135

Table 44. Phase Noise (dBc/Hz), All Options, with UNY, All Ports – Supplemental Performance Data

CW Frequency	100 Hz Offset	1 kHz Offset	10 kHz Offset	100 kHz Offset	1 MHz Offset	10 MHz Offset
43.5 GHz	-82	-106	-113	-117	-129	-135
50 GHz	-81	-101	-109	-116	-127	-132
67 GHz	-81	-101	-111	-114	-126	-131

Phase Noise with Option UNY (Typical)

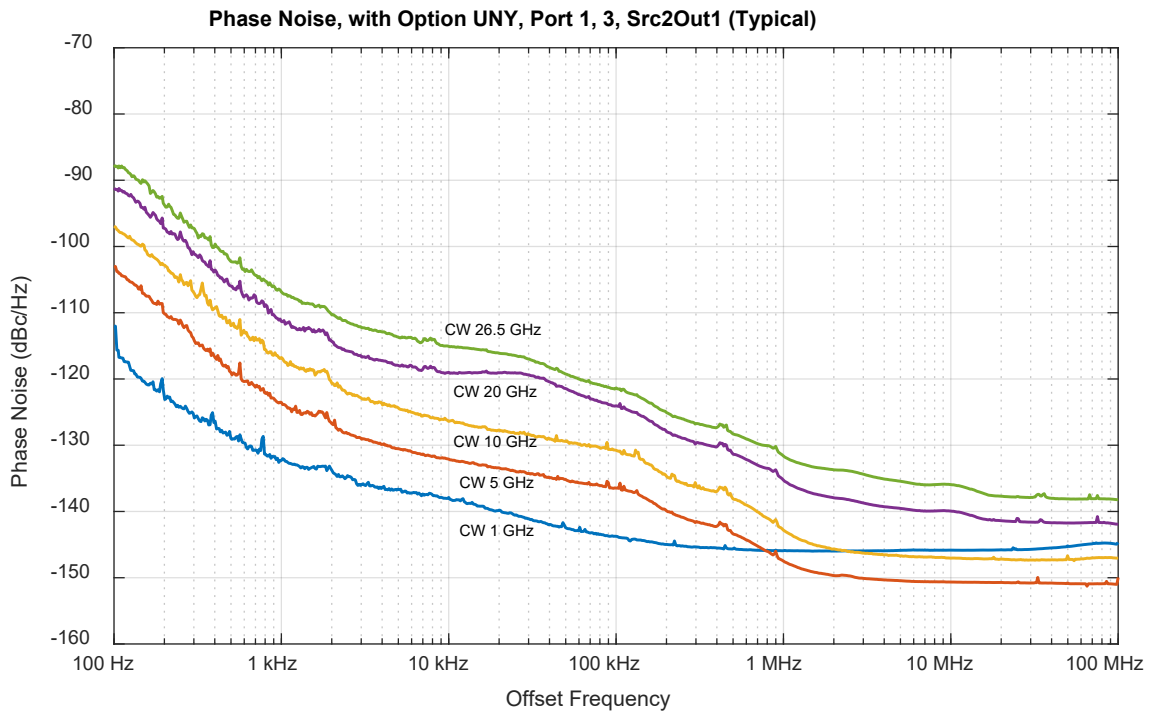

Phase Noise with Option UNY (Supplemental Performance Data)

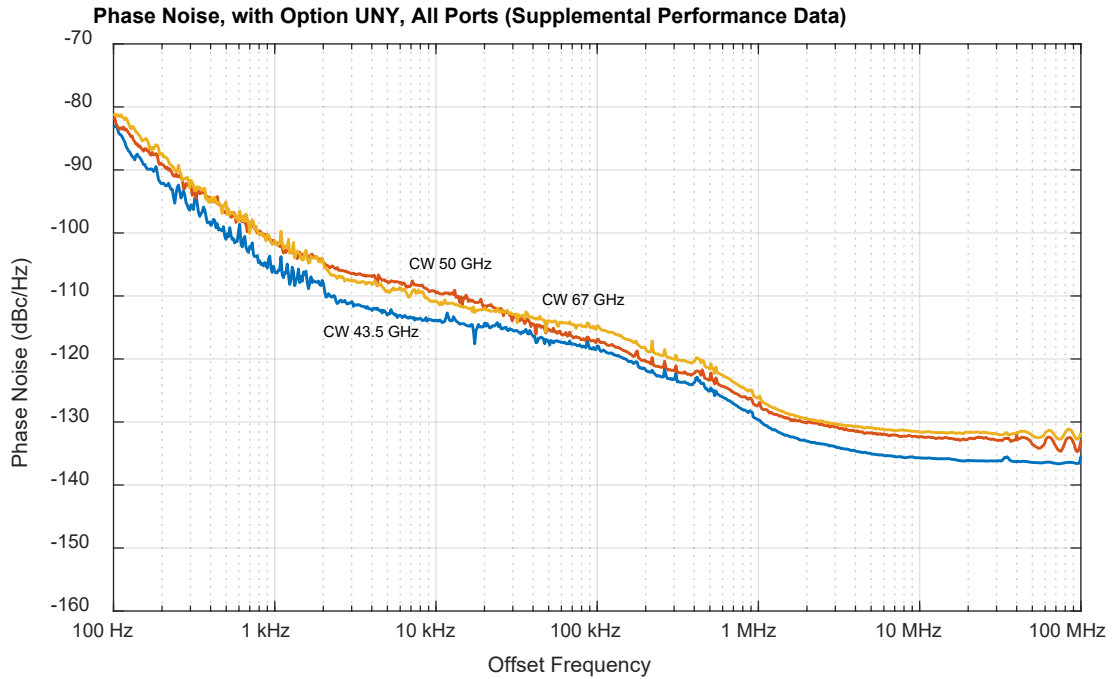

Table 45. Phase Noise (dBc/Hz) All LFE Options (LFE Enabled), with UNY, All Ports - Typical

Description	1 kHz Offset	10 kHz Offset	100 kHz Offset	1 MHz Offset
500 Hz to 100 MHz	-120	-130	-125	-135

Table 46. Phase Noise (dBc/Hz), All Options, without UNY, All Ports - Typical

CW Frequency	100 Hz Offset	1 kHz Offset	10 kHz Offset	100 kHz Offset	1 MHz Offset	10 MHz Offset
1 GHz	-94	-116	-130	-141	-145	-146
5 GHz	-83	-106	-119	-128	-139	-147
10 GHz	-78	-100	-113	-122	-133	-142
20 GHz	-72	-94	-107	-116	-127	-135
26.5 GHz	-67	-90	-104	-114	-124	-132

Table 47. Phase Noise (dBc/Hz), All Options, without UNY, All Ports – Supplemental Performance Data

CW Frequency	100 Hz Offset	1 kHz Offset	10 kHz Offset	100 kHz Offset	1 MHz Offset	10 MHz Offset
43.5 GHz	-70	-90	-103	-112	-122	-130
50 GHz	-66	-86	-101	-111	-121	-130
67 GHz	-64	-85	-99	-108	-119	-127

Phase Noise, CW 10 GHz, with Option UNY and without Option UNY

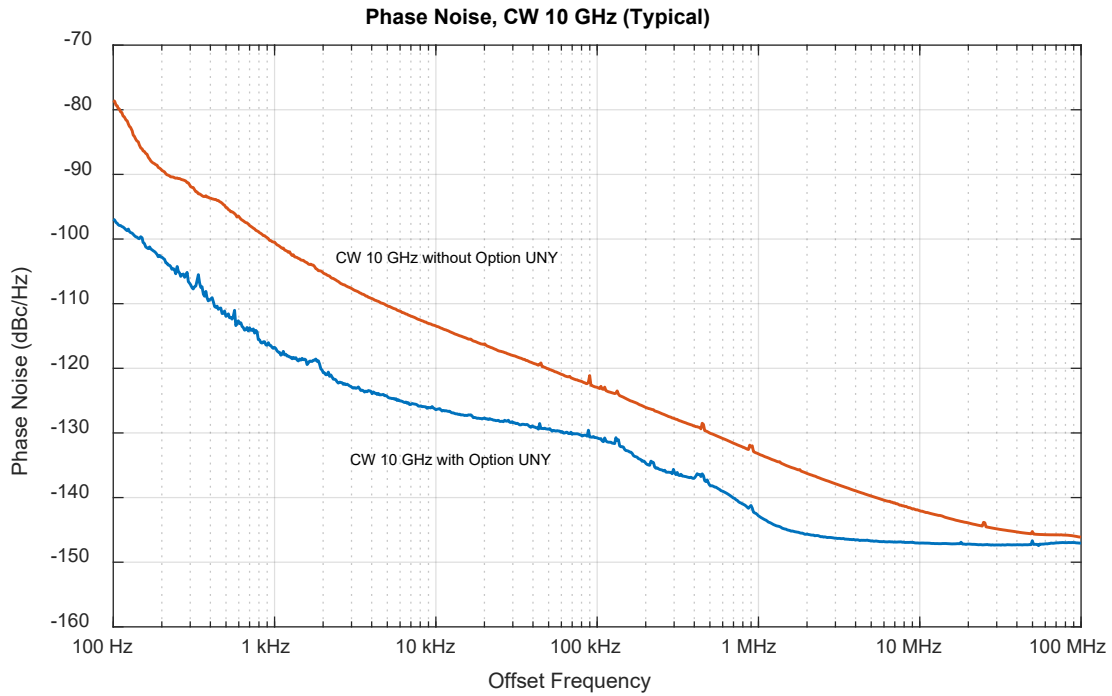

Test Port Input

Table 48. Noise Floor (dBm) @ 10 Hz IFBW, All Options, All Ports

Total average (rms) noise power calculated as the mean value of a linear magnitude trace expressed in dBm.

May typically be degraded at particular frequencies below 500 MHz due to spurious receiver residuals.

Description	Specification	Typical
10 MHz to 50 MHz ¹	-70	-76
50 MHz to 100 MHz ¹	-92	-97
100 MHz to 500 MHz	-101	-106
500 MHz to 1 GHz	-110	-115
1 GHz to 10 GHz	-114	-119
10 GHz to 13.5 GHz	-114	-120
13.5 GHz to 24 GHz	-116	-121
24 GHz to 26.5 GHz	-117	-121
26.5 GHz to 35 GHz	-106	-112
35 GHz to 40 GHz	-104	-110
40 GHz to 50 GHz	-101	-108
50 GHz to 60 GHz	-101	-107
60 GHz to 67 GHz	-101	-108
67 GHz to 70 GHz	--	-106

¹ With an LFE option installed and LFE disabled, applied to frequencies ≤ 100 MHz. Above 100 MHz, performance is the same for both LFE enabled or disabled. For LFE enabled performance ≤ 100 MHz, see Table 49.

Table 49. Test Port Noise Floor (dBm) @ 10 Hz IFBW, All LFE Options (LFE Enabled)

Description	Specification	Typical
500 Hz to 900 Hz	--	-93
900 Hz to 1 kHz	-90	-96
1 kHz to 10 kHz	-91	-96
10 kHz to 100 kHz	-101	-105
100 kHz to 1 MHz	-107	-110
1 MHz to 5 MHz	-108	-112
5 MHz to 10 MHz	-102	-106
10 MHz to 50 MHz	-102	-106
50 MHz to 100 MHz ¹	-102	-106

¹May be degraded at 100 MHz due to spurious receiver residuals.

Table 50. Direct Receiver Access Input Noise Floor (dBm) @ 10 Hz IFBW

Total average (rms) noise power calculated as the mean value of a linear magnitude trace expressed in dBm.

May typically be degraded at particular frequencies below 500 MHz due to spurious receiver residuals.

Description	Specification	Typical
	Options 201, 205, 219, 220, 401, 405, 419, 420	Options 201, 205, 219, 220, 401, 405, 419, 420
10 MHz to 50 MHz	--	-116
50 MHz to 100 MHz	-104	-124
100 MHz to 500 MHz	-113	-133
500 MHz to 1 GHz	-122	-142
1 GHz to 2 GHz	-126	-133
2 GHz to 10 GHz	-125	-133
10 GHz to 13.5 GHz	-125	-134
13.5 GHz to 24 GHz	-127	-135
24 GHz to 26.5 GHz	-128	-135
26.5 GHz to 30 GHz	-117	-126
30 GHz to 35 GHz	-116	-125
35 GHz to 40 GHz	-114	-123
40 GHz to 45 GHz	-111	-120
45 GHz to 50 GHz	-110	-120
50 GHz to 67 GHz	-109	-118
67 GHz to 70 GHz	--	-116

Table 51. 0.1 dB Receiver Compression at Test Port (dBm), Option 201, 219, 401, 419, and All LFE Options - Typical

Description	Test Port Power (dBm)
10 MHz to 100 MHz ¹	15
100 MHz to 30 GHz	12
30 GHz to 67 GHz	11

¹ With an LFE option installed and LFE disabled, applied to frequencies ≤ 100 MHz. Above 100 MHz, performance is the same for both LFE enabled or disabled. For LFE enabled performance ≤ 100 MHz, see Table Table 52.

Table 52. 0.1 dB Compression, All Ports, All LFE Options (LFE Enabled) - Typical

Description	Test Port Power (dBm)
500 Hz to 900 Hz	13
900 Hz to 1 kHz	13
1 kHz to 10 kHz	13
10 kHz to 100 kHz	13
100 kHz to 1 MHz	13
1 MHz to 5 MHz	11
5 MHz to 10 MHz	13
10 MHz to 50 MHz	14
50 MHz to 100 MHz	14

Table 53. Receiver Compression at Test Power - Specification

Description	Test Port Power (dBm)			Receiver compression	
	Option 200, 400	Option 201, 205, 401, 405	Option 219, 220, 419, 420	Magnitude (dB)	Phase (degrees)
10 MHz to 500 MHz ¹	--	--	--	--	--
500 MHz to 2 GHz	10	13	13	0.15	1.2
2 GHz to 3.2 GHz	7	12	11	0.15	1.2
3.2 GHz to 10 GHz	10	13	12	0.15	1.2
10 GHz to 13.5 GHz	8	11	9	0.15	1.2
13.5 GHz to 16 GHz	8	12	10	0.15	1.2
16 GHz to 20 GHz	6	11	8	0.15	1.2
20 GHz to 24 GHz	6	11	8	0.15	1.2
24 GHz to 30 GHz	6	10	8	0.15	1.2
30 GHz to 35 GHz	5	9	8	0.15	1.2
35 GHz to 40 GHz	0	8	8	0.15	1.2
40 GHz to 67 GHz	4	10	8	0.15	1.2

¹ Test port receiver compression at input levels below 500 MHz is negligible due to coupler roll off.

Table 54. Compression, All Ports, All LFE Options (LFE Enabled)- Specification

Description	Test Port Power (dBm)	Receiver Compression	
	All Options	Magnitude (dB)	Phase (degrees)
500 Hz to 900 Hz	--	--	--
900 Hz to 1 kHz	10	0.2	1
1 kHz to 10 kHz	12	0.2	1
10 kHz to 100 kHz	12	0.2	1
100 kHz to 1 MHz	12	0.2	1
1 MHz to 5 MHz	10	0.2	1
5 MHz to 10 MHz	9	0.2	1
10 MHz to 50 MHz	8	0.2	1
50 MHz to 100 MHz	8	0.2	1

Table 55. Trace Noise¹ Magnitude (dB rms)

Description	Specification	Typical		
	1 kHz IFBW	1 kHz IFBW	100 kHz IFBW	600 kHz IFBW
10 MHz to 50 MHz ²	0.05	0.0177	0.173	0.416
50 MHz to 100 MHz ²	0.006	0.0012	0.012	0.029
100 MHz to 500 MHz	0.002	0.0006	0.006	0.014
500 MHz to 1 GHz	0.002	0.0004	0.003	0.006
1 GHz to 26.5 GHz	0.002	0.0005	0.002	0.005
26.5 GHz to 50 GHz	0.003	0.0006	0.005	0.012
50 GHz to 67 GHz	0.003	0.0007	0.006	0.013
67 GHz to 70 GHz	--	0.0010	0.007	0.016

¹ Ratioed measurement, nominal power at test port.

² With an LFE option installed and LFE disabled, applied to frequencies ≤ 100 MHz. Above 100 MHz, performance is the same for both LFE enabled or disabled. For LFE enabled performance ≤ 100 MHz, see Table 56.

Table 56. Trace Noise¹ Magnitude (dB rms), All Ports, All LFE Options (LFE Enabled)

Description	Specification		Typical			
	100 Hz IFBW	1 kHz IFBW	100 Hz IFBW	1 kHz IFBW	100 kHz IFBW	600 kHz IFBW
500 Hz to 900 Hz	--	--	0.002	--	--	--
900 Hz to 4 kHz	0.004	--	0.001	--	--	--
4 kHz to 300 kHz	--	0.004	--	0.002	--	--
300 kHz to 2 MHz	--	0.004	--	0.001	0.01	--
2 MHz to 100 MHz	--	0.004	--	0.001	0.01	0.025

¹ Ratioed measurement, -5 dBm at test port.

Table 57. Trace Noise¹ Phase (deg rms), All Options

Description	Specification				Typical			
	1 kHz IFBW		100 kHz IFBW		600 kHz IFBW			
10 MHz to 50 MHz ²	0.400	0.1228	1.205	2.928				
50 MHz to 100 MHz ²	0.040	0.0083	0.080	0.196				
100 MHz to 500 MHz	0.020	0.0040	0.037	0.097				
500 MHz to 1 GHz	0.020	0.0017	0.015	0.037				
1 GHz to 26.5 GHz	0.020	0.0075	0.015	0.031				
26.5 GHz to 43.5 GHz	0.030	0.0125	0.040	0.091				
43.5 GHz to 50 GHz	0.035	0.0149	0.040	0.092				
50 GHz to 67 GHz	0.045	0.0200	0.048	0.110				
67 GHz to 70 GHz	--	0.0213	0.050	0.119				

¹ Ratioed measurement, nominal power at test port.

² With an LFE option installed and LFE disabled, applied to frequencies ≤ 100 MHz. Above 100 MHz, performance is the same for both LFE enabled or disabled. For LFE enabled performance ≤ 100 MHz, see Table 58.

Table 58. Trace Noise¹ Phase (deg rms), All Ports, All LFE Options (LFE Enabled)

Description	Specification		Typical			
	100 Hz IFBW	1 kHz IFBW	100 Hz IFBW	1 kHz IFBW	100 kHz IFBW	600 kHz IFBW
500 Hz to 900 Hz	--	--	0.012	--	--	--
900 Hz to 4 kHz	0.03	--	0.008	--	--	--
4 kHz to 300 kHz	--	0.03	--	0.014	--	--
300 kHz to 2 MHz	--	0.03	--	0.007	0.064	--
2 MHz to 100 MHz	--	0.03	--	0.007	0.068	0.166

¹ Ratioed measurement, -5 dBm at test port.

Table 59. Reference Level Magnitude, All Models and Options - Specification

Description	Magnitude (dB)	Phase (°)
Range	±500	±500
Resolution	0.001	0.01

Table 60. Stability, All Options - Typical

Description	Magnitude (dB/°C)	Phase (°/°C)
10 MHz to 50 MHz ¹	0.03	0.400
50 MHz to 3.2 GHz ¹	0.01	0.100
3.2 GHz to 20 GHz	0.01	0.200
20 GHz to 32 GHz	0.01	0.300
32 GHz to 35 GHz	0.02	0.400
35 GHz to 50 GHz	0.02	0.400
50 GHz to 67 GHz	0.03	0.600
67 GHz to 70 GHz	0.06	1.200

¹ With an LFE option installed and LFE disabled, applied to frequencies ≤ 100 MHz. Above 100 MHz, performance is the same for both LFE enabled or disabled. For LFE enabled performance ≤ 100 MHz, see Table 61.

Table 61. Stability¹, All LFE Options (LFE Enabled) - Typical

Description	Magnitude (dB/°C)	Phase (°/°C)
500 Hz to 900 Hz	0.010	0.2
900 Hz to 1 kHz	0.010	0.2
1 kHz to 10 kHz	0.010	0.2
10 kHz to 100 kHz	0.010	0.2
100 kHz to 1 MHz	0.010	0.1
1 MHz to 5 MHz	0.010	0.1
5 MHz to 10 MHz	0.010	0.1
10 MHz to 50 MHz	0.010	0.1
50 MHz to 100 MHz	0.020	0.1

¹ Stability is defined as a ratio measurement made at the test port.

Table 62. Damage Input Level, All Ports

Description	Option 200, 201, 219, 400, 401, 419	All LFE Options
RF, DC	27 dBm, 40 V	20 dBm, 50 V

Phase Noise Measurement Performance (with S930317B phase noise measurement application)¹

- Offset frequency range: 0.1 Hz to 10 MHz
- Sweep speed (typical): 34 seconds (1 Hz to 10 MHz offset in Normal mode)

Table 63. Absolute Phase Noise Sensitivity (dBc/Hz), in Best mode - Supplemental Performance Data ²

Input Power level: +5 dBm (-5 dBm at 50 GHz)

Phase Noise	Offset Frequency								
Input Frequency	1 Hz	10 Hz	100 Hz	1 kHz	10 kHz	100 kHz	300 kHz	1 MHz	10 MHz
1 GHz	-55	-88	-112	-127	-132	-134	-134	-134	-134
10 GHz	-36	-69	-97	-117	-124	-130	-132	-136	-137
20 GHz	-31	-64	-90	-111	-120	-124	-125	-132	-134
40 GHz	-23	-58	-84	-104	-113	-117	-123	-125	-129
50 GHz	-18	-54	-81	-100	-109	-113	-116	-121	-123

Table 64. Absolute AM Noise Sensitivity (dBc/Hz), in Best mode - Supplemental Performance Data

Input Power level: +5 dBm (-5 dBm at 50 GHz)

AM Noise	Offset Frequency								
Input Frequency	1 Hz	10 Hz	100 Hz	1 kHz	10 kHz	100 kHz	300 kHz	1 MHz	10 MHz
1 GHz	-96	-104	-110	-119	-128	-132	-132	-135	-137
10 GHz	-97	-104	-110	-118	-128	-134	-135	-138	-139
20 GHz	-96	-104	-112	-116	-125	-132	-129	-136	-136
40 GHz	-93	-102	-109	-114	-123	-127	-130	-130	-132
50 GHz	-91	-96	-105	-114	-119	-122	-117	-125	-122

¹ The input frequency in the sensitivity tables in this section is limited to the highest frequency of the PNA model.

² For embedded-LO frequency converters, the frequency used for the table should be that of the embedded-LO.

Absolute Phase Noise Sensitivity (dBc/Hz) - Supplemental Performance Data

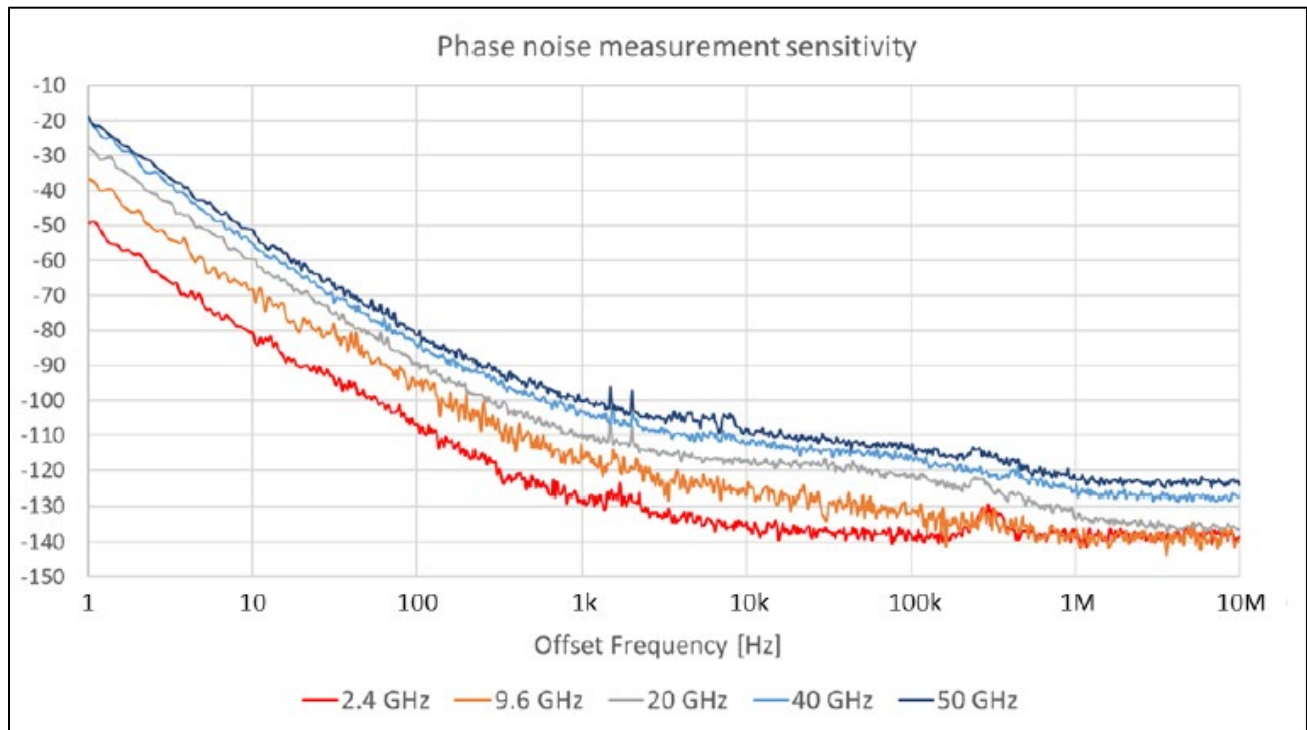

Single-Channel Residual Noise Measurement ³

Table 65. Single-Channel Residual Phase Noise Sensitivity (dBc/Hz), with Option UNY in Best mode - Supplemental Performance Data

Input Power level: +10 dBm (+6 dBm at 40 GHz, -2 dBm at 50 GHz)

Residual Phase Noise	Offset Frequency								
	1 Hz	10 Hz	100 Hz	1 kHz	10 kHz	100 kHz	300 kHz	1 MHz	10 MHz
1 GHz	-102	-110	-115	-123	-131	-136	-136	-137	-137
10 GHz	-92	-99	-105	-113	-122	-131	-134	-139	-140
20 GHz	-83	-93	-100	-112	-118	-125	-124	-132	-136
40 GHz	-78	-85	-93	-106	-110	-122	-126	-128	-129
50 GHz	-75	-81	-91	-102	-110	-120	-119	-125	-125

Table 66. Single-Channel Residual AM Noise Sensitivity (dBc/Hz), with Option UNY in Best mode - Supplemental Performance Data

Input Power level: +10 dBm (+6 dBm at 40 GHz, -2 dBm at 50 GHz)

Residual AM Noise	Offset Frequency								
	1 Hz	10 Hz	100 Hz	1 kHz	10 kHz	100 kHz	300 kHz	1 MHz	10 MHz
1 GHz	-97	-104	-112	-120	-117	-128	-130	-134	-138
10 GHz	-97	-106	-111	-120	-121	-129	-134	-137	-142
20 GHz	-99	-104	-112	-120	-123	-120	-123	-130	-136
40 GHz	-96	-102	-110	-117	-118	-128	-132	-131	-133
50 GHz	-91	-99	-109	-114	-120	-125	-118	-125	-127

³ The data is when a THRU device is connected, in other words, when the input and output frequencies are the same. The single-channel residual noise measurement is used for the phase noise measurements for frequency converting devices, and the sensitivity is determined as the absolute phase noise sensitivity at the embedded-LO frequency (Table 63). In the single-channel residual noise measurement mode, the phase or AM noise of the DUT input signal is not measured. The measurement can be done when the phase or AM noise of the signal generated by the DUT is larger than that of the DUT input signal supplied by the PNA internal signal source.

Single-Channel Residual Phase Noise Sensitivity (dBc/Hz) - Supplemental Performance Data

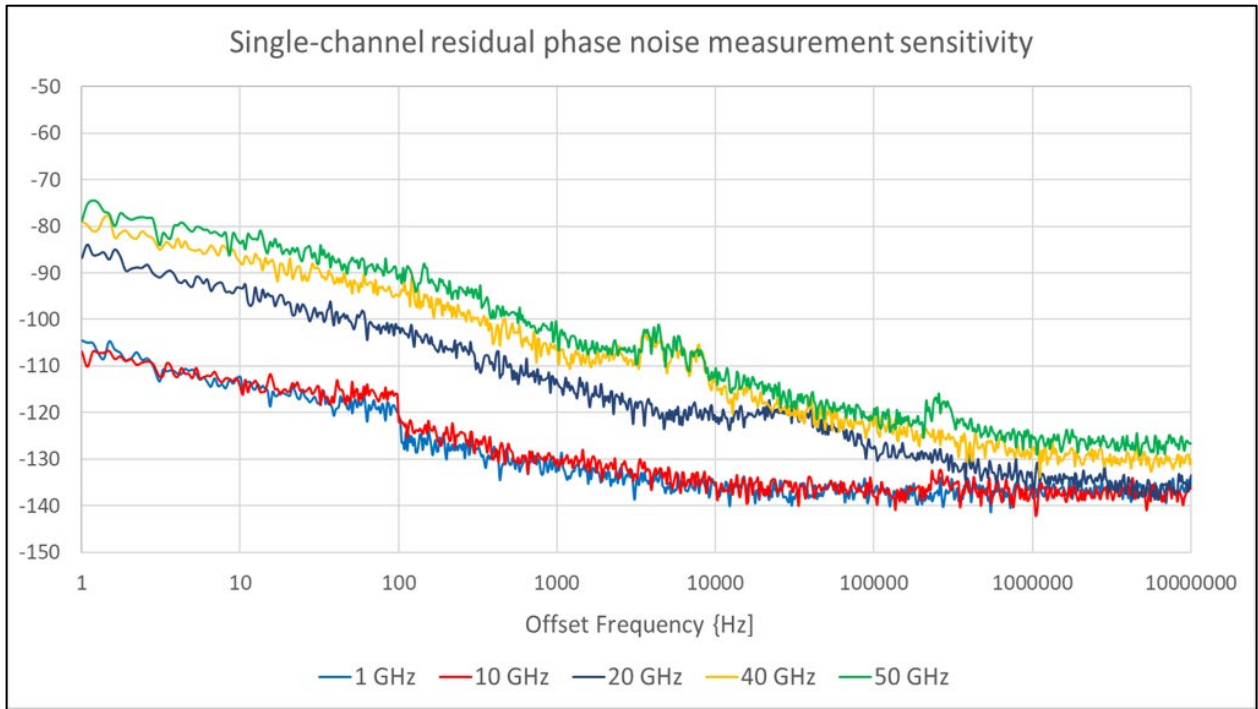

Table 67. Single-Channel Residual Phase Noise Sensitivity (dBc/Hz), without Option UNY in Best mode - Supplemental Performance Data ⁴

Input Power level: +10 dBm (+6 dBm at 40 GHz, 0 dBm at 50 GHz)

Residual Phase Noise	Offset Frequency								
	Input Frequency	1 Hz	10 Hz	100 Hz	1 kHz	10 kHz	100 kHz	300 kHz	1 MHz
1 GHz	-94	-95	-100	-120	-133	-136	-138	-137	-136
10 GHz	-77	-78	-83	-102	-114	-124	-129	-135	-138
20 GHz	-70	-74	-75	-95	-109	-118	-127	-128	-133
40 GHz	-64	-67	-70	-92	-102	-112	-116	-121	-128
50 GHz	-61	-63	-66	-87	-101	-109	-113	-119	-125

Table 68. Single-Channel Residual AM Noise Sensitivity (dBc/Hz), without Option UNY in Best mode - Supplemental Performance Data

Input Power level: +10 dBm (+6 dBm at 40 GHz, 0 dBm at 50 GHz)

Residual AM Noise	Offset Frequency								
	Input Frequency	1 Hz	10 Hz	100 Hz	1 kHz	10 kHz	100 kHz	300 kHz	1 MHz
1 GHz	-105	-110	-123	-125	-134	-138	-139	-143	-138
10 GHz	-104	-110	-116	-125	-133	-134	-133	-141	-141
20 GHz	-104	-109	-116	-127	-127	-126	-128	-133	-137
40 GHz	-103	-110	-115	-125	-120	-130	-126	-130	-132
50 GHz	-98	-106	-111	-121	-124	-125	-122	-129	-129

⁴ The data is when a THRU device is connected, in other words, when the input and output frequencies are the same. The single-channel residual noise measurement is used for the phase noise measurements for frequency converting devices, and the sensitivity is determined as the absolute phase noise sensitivity at the embedded-LO frequency (Table 63). In the single-channel residual noise measurement mode, the phase or AM noise of the DUT input signal is not measured. The measurement can be done when the phase or AM noise of the signal generated by the DUT is larger than that of the DUT input signal supplied by the PNA internal signal source.

2-Channel Residual Noise Measurement for Non-Frequency Converting Devices⁵

Table 69. 2-Channel Residual Phase Noise Sensitivity (dBc/Hz) in Best mode - Supplemental Performance Data

Input Power level: +10 dBm (+6 dBm at 40 GHz, -3 dBm at 50 GHz)

Residual Phase Noise	Offset Frequency								
	1 Hz	10 Hz	100 Hz	1 kHz	10 kHz	100 kHz	300 kHz	1 MHz	10 MHz
1 GHz	-107	-116	-127	-134	-132	-134	-131	-133	-132
10 GHz	-101	-110	-120	-126	-134	-135	-134	-138	-136
20 GHz	-99	-105	-113	-120	-128	-131	-129	-134	-135
40 GHz	-93	-101	-109	-115	-121	-124	-125	-126	-127
50 GHz	-90	-99	-106	-113	-117	-118	-119	-120	-120

Table 70. 2-Channel Residual AM Noise Sensitivity (dBc/Hz) in Best mode - Supplemental Performance Data

Input Power level: +10 dBm (+6 dBm at 40 GHz, -3 dBm at 50 GHz)

Residual AM Noise	Offset Frequency								
	1 Hz	10 Hz	100 Hz	1 kHz	10 kHz	100 kHz	300 kHz	1 MHz	10 MHz
1 GHz	-99	-106	-109	-120	-131	-133	-138	-137	-134
10 GHz	-95	-105	-113	-121	-130	-134	-136	-139	-139
20 GHz	-96	-104	-113	-120	-129	-128	-129	-136	-136
40 GHz	-98	-107	-112	-118	-120	-127	-129	-130	-131
50 GHz	-93	-102	-110	-115	-120	-121	-119	-122	-122

⁵ Both the phase or AM noise of the DUT input signal and that of the DUT output signal are measured.

2-Channel Residual Phase Noise Sensitivity (dBc/Hz) - Supplemental Performance Data

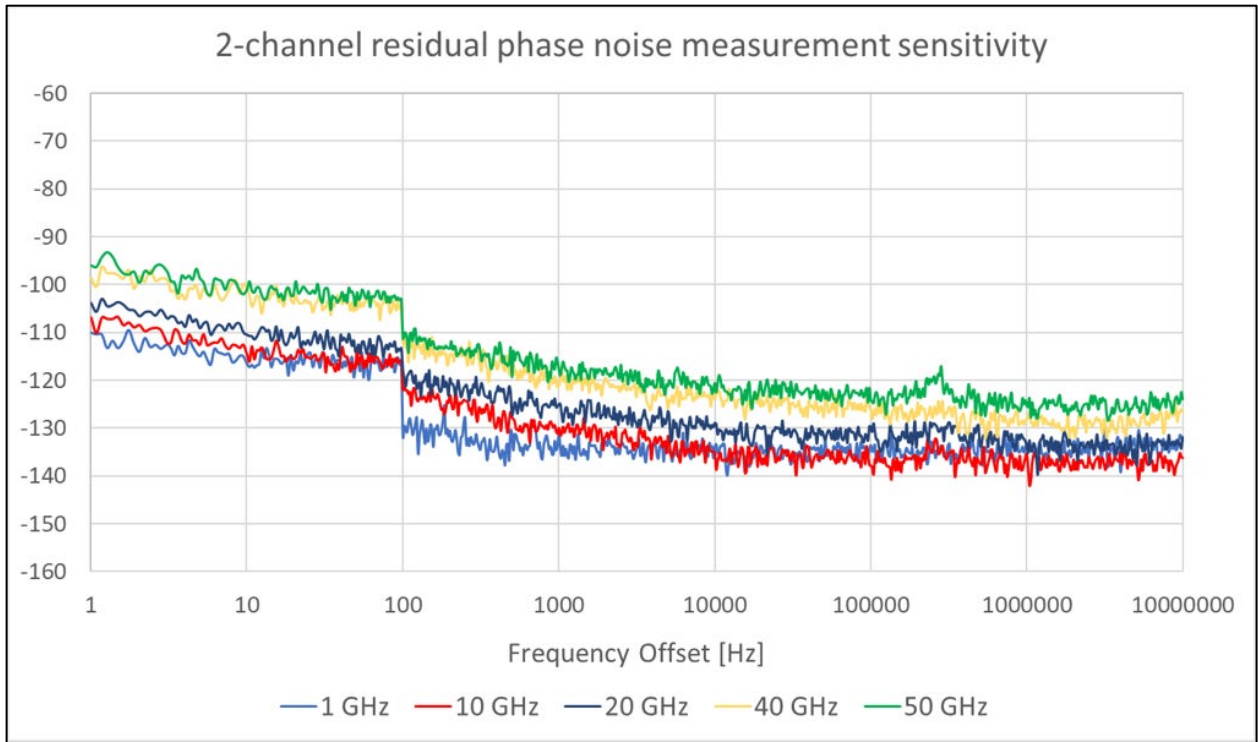

Dynamic Accuracy

Table 71. N5227B Dynamic Accuracy - Specification

Dynamic accuracy is verified with the following measurements:

- Compression over frequency
- IF linearity at a single frequency of 99.6 MHz or 1.998765 GHz using a reference level of -20 dBm for an input power range of 0 to -60 dBm. For value below -60 dBm, refer to “VNA Receiver Dynamic Accuracy Specifications and Uncertainties”.

Please download our free Uncertainty Calculator from http://www.keysight.com/find/na_calculator to generate the curves for your PNA.

N5227B Dynamic Accuracy, 900 Hz, All LFE Options (LFE Enabled) - Specification

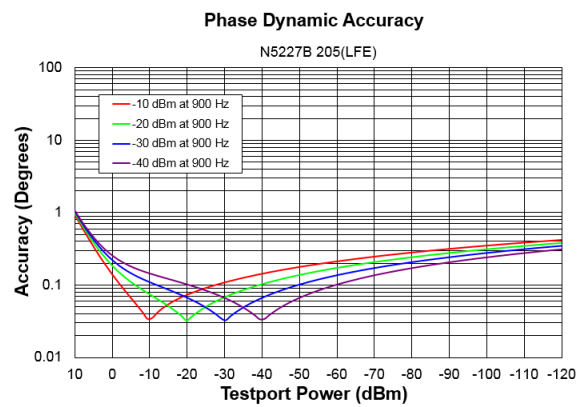
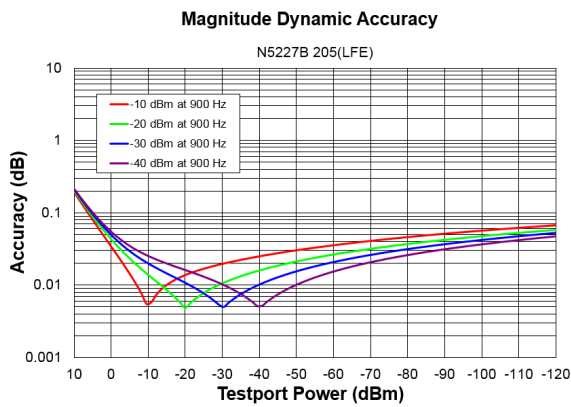

N5227B Dynamic Accuracy, 10 MHz, All LFE Options (LFE Enabled) - Specification

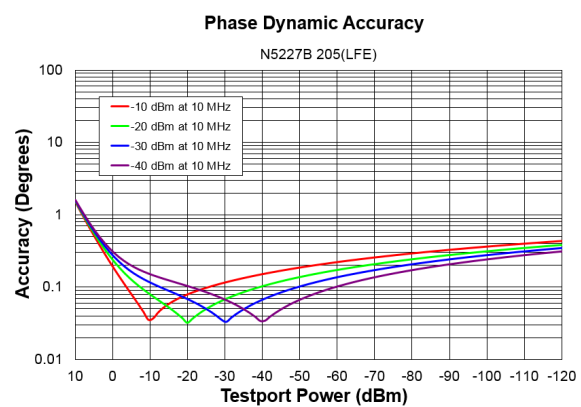
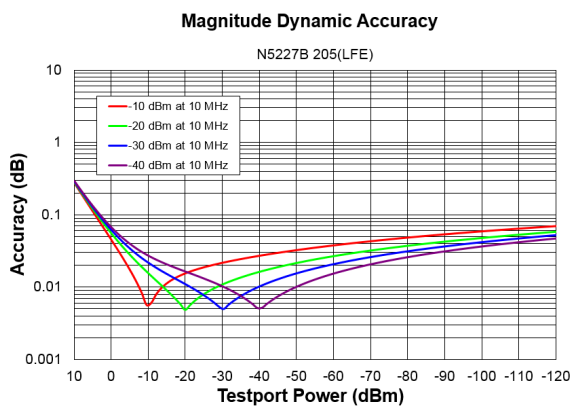

N5227B Dynamic Accuracy, 100 MHz, All LFE Options (LFE Enabled) - Specification

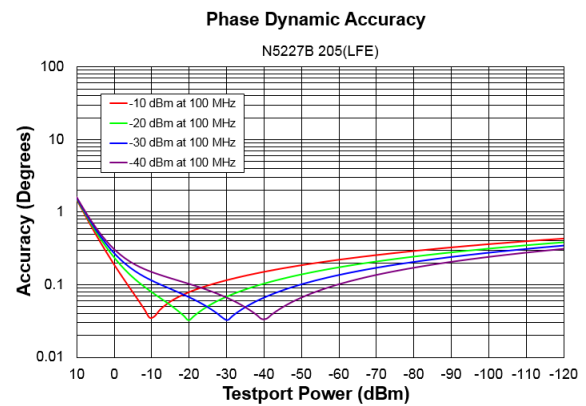
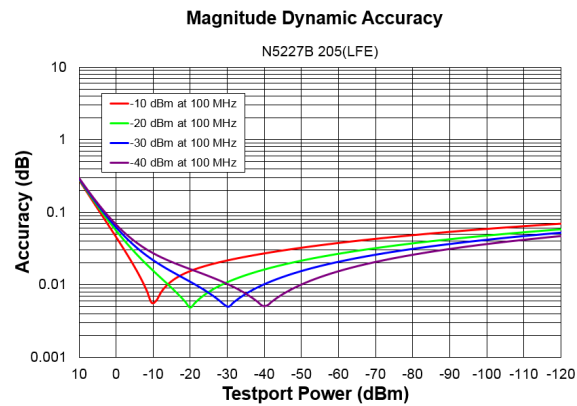

N5227B Dynamic Accuracy, 10 MHz - Specification

NOTE

The plots are valid for all options.

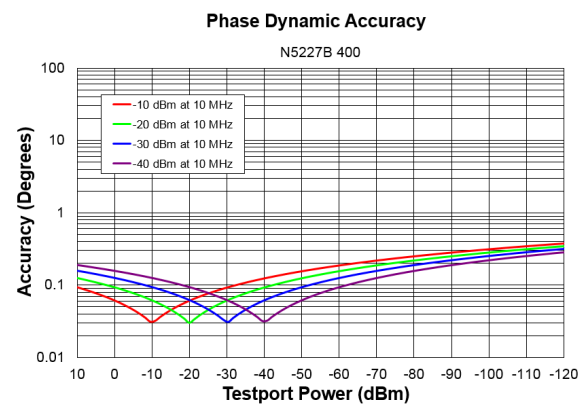
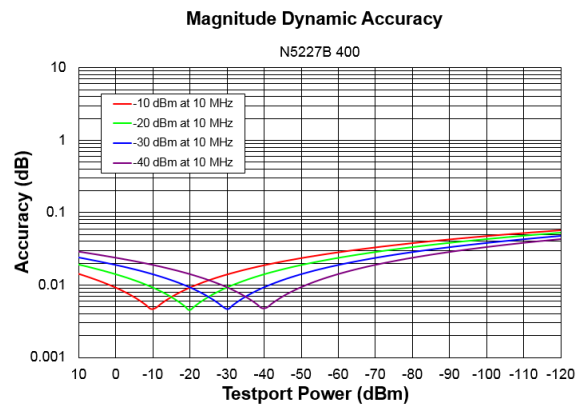

N5227B Dynamic Accuracy, 50 MHz - Specification

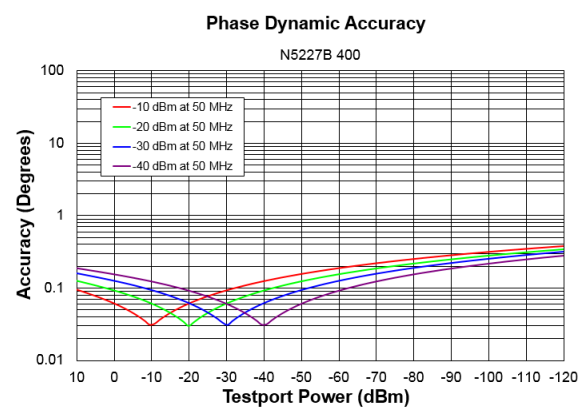
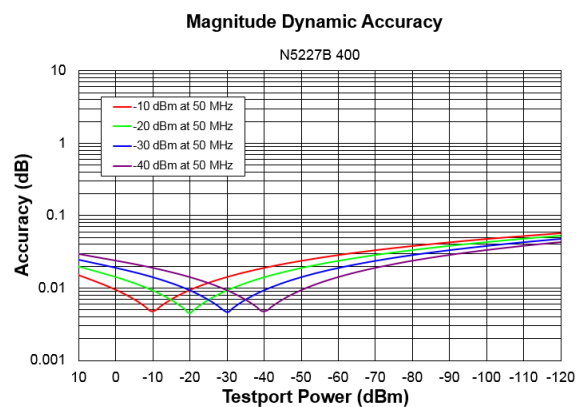

N5227B Dynamic Accuracy, 500 MHz - Specification

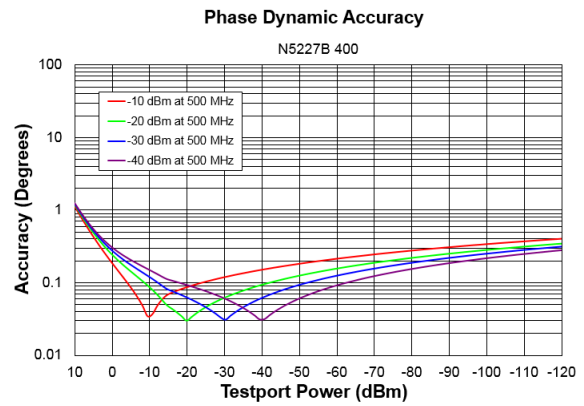
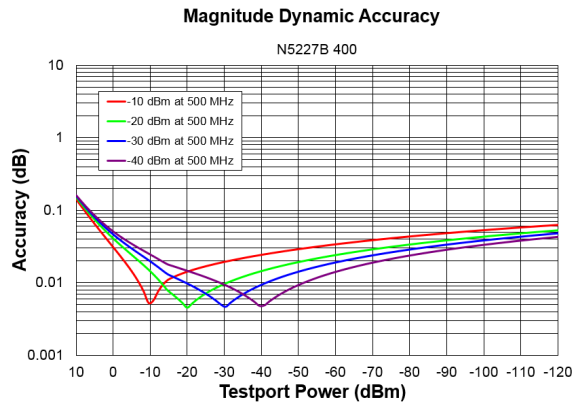

N5227B Dynamic Accuracy, 1 GHz - Specification

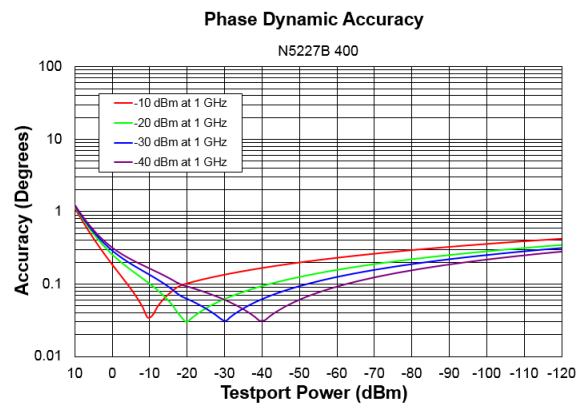
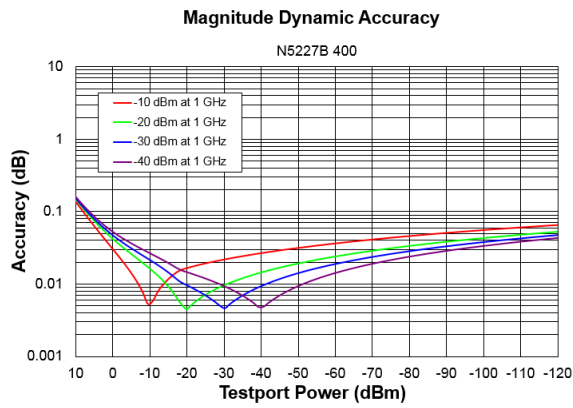

N5227B Dynamic Accuracy, 2 GHz - Specification

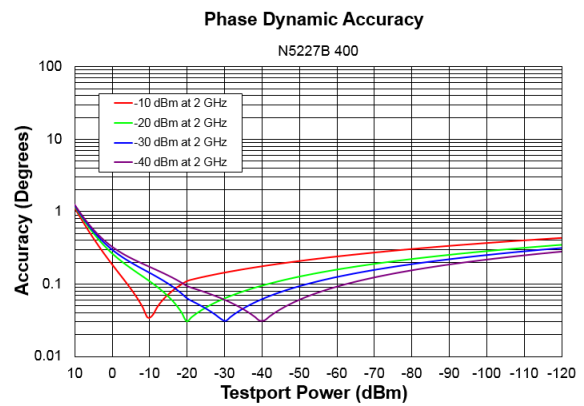
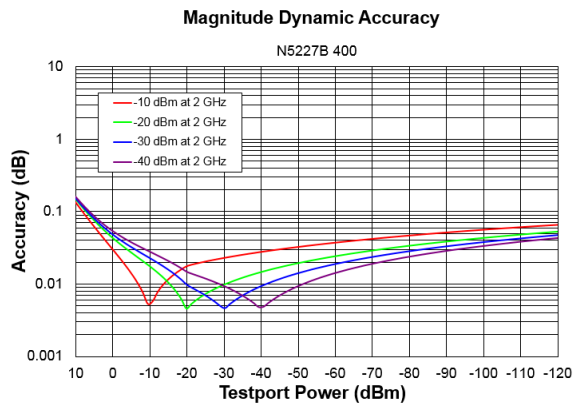

N5227B Dynamic Accuracy, 20 GHz - Specification

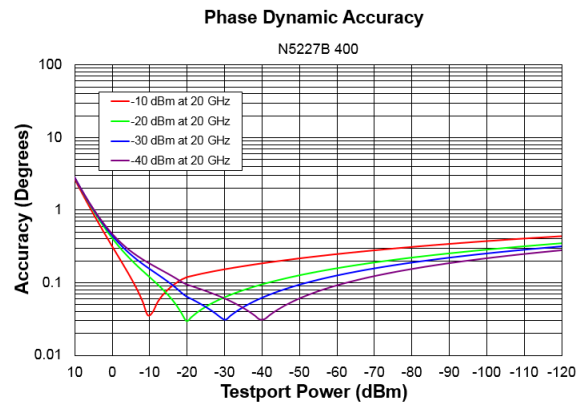
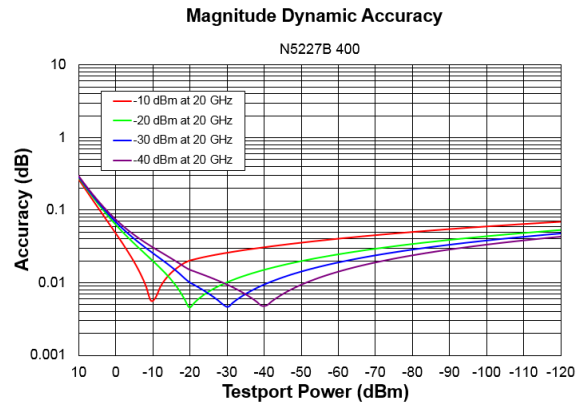

N5227B Dynamic Accuracy, 26.5 GHz - Specification

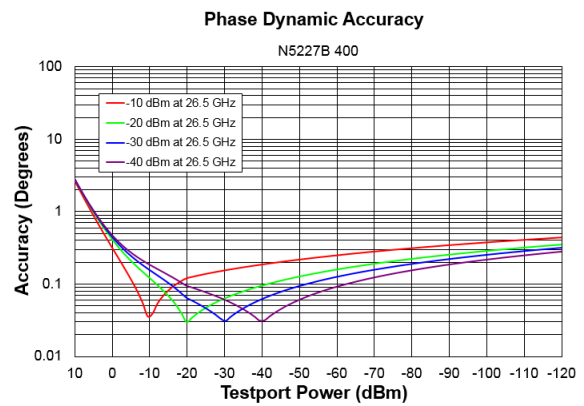
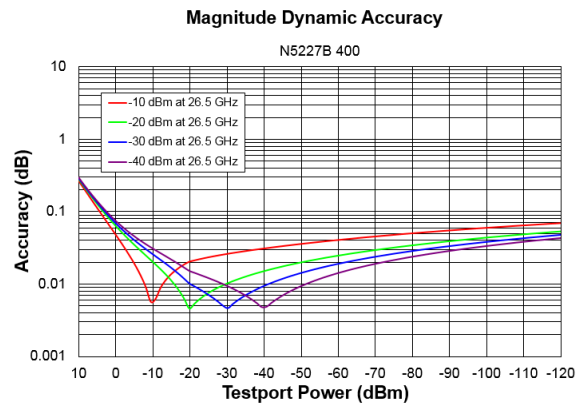

N5227B Dynamic Accuracy, 35 GHz - Specification

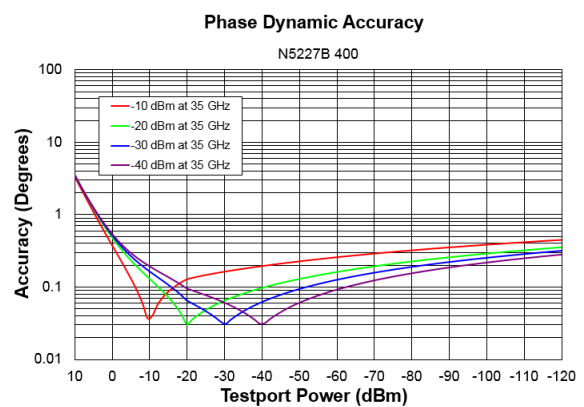
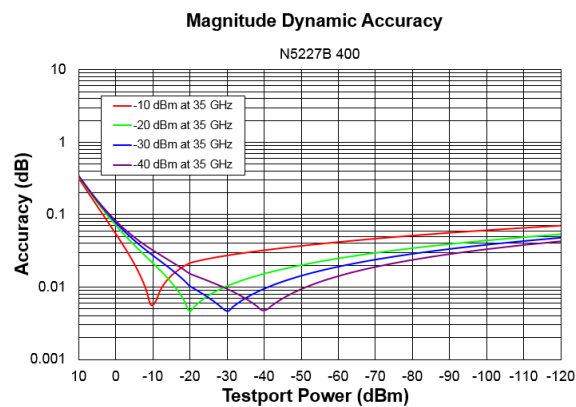

N5227B Dynamic Accuracy, 40 GHz - Specification

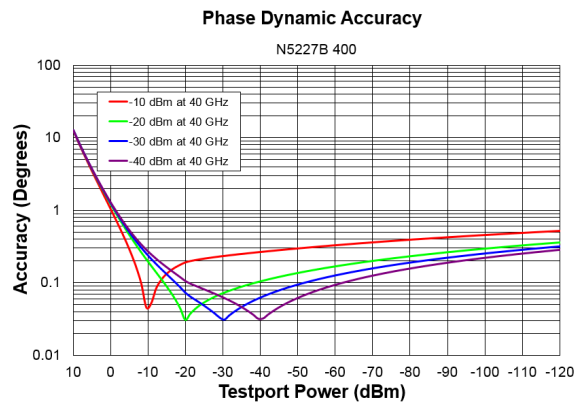
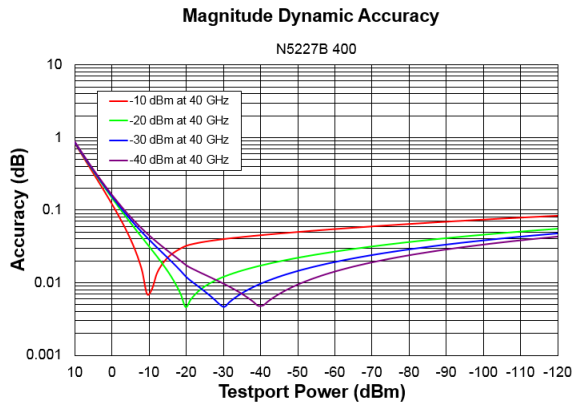

N5227B Dynamic Accuracy, 50 GHz - Specification

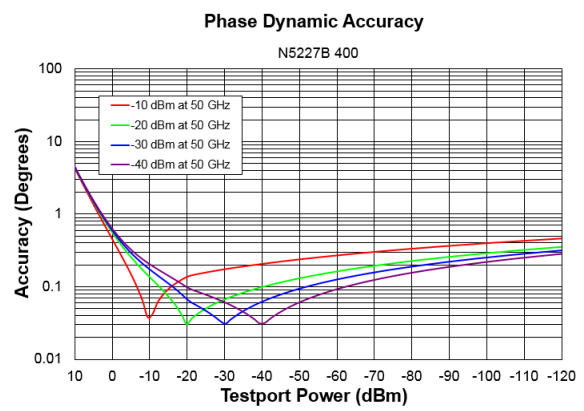
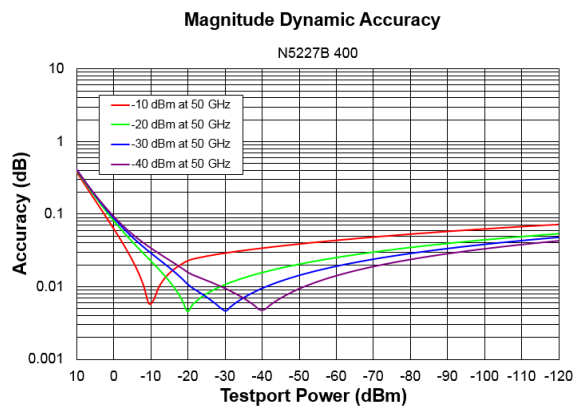

N5227B Dynamic Accuracy, 60 GHz - Specification

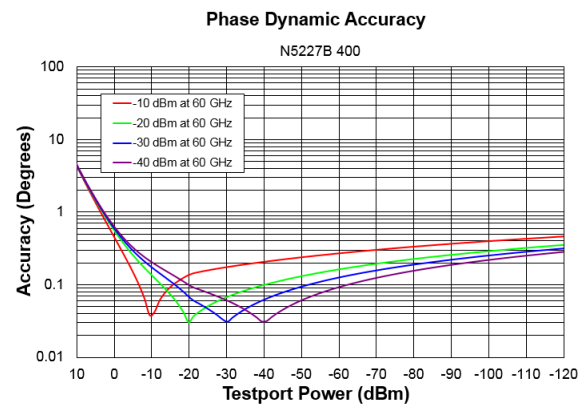
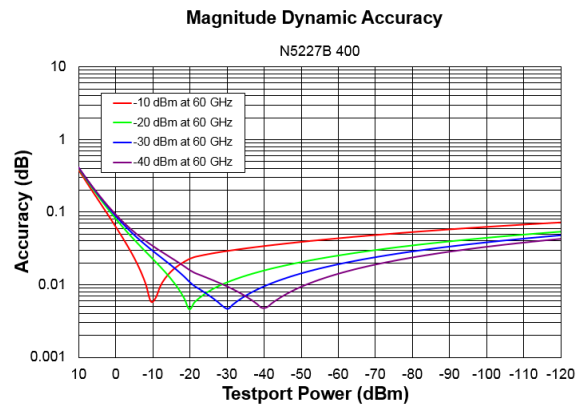

N5227B Dynamic Accuracy, 67 GHz - Specification

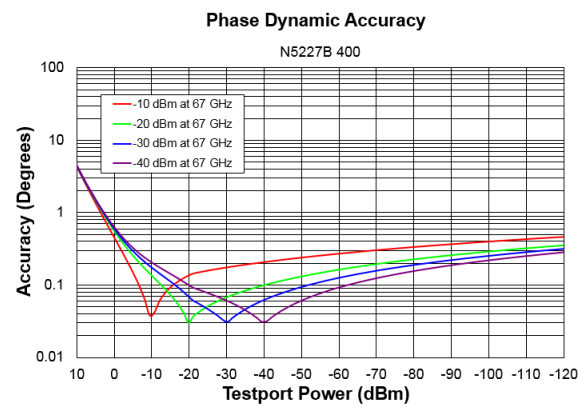
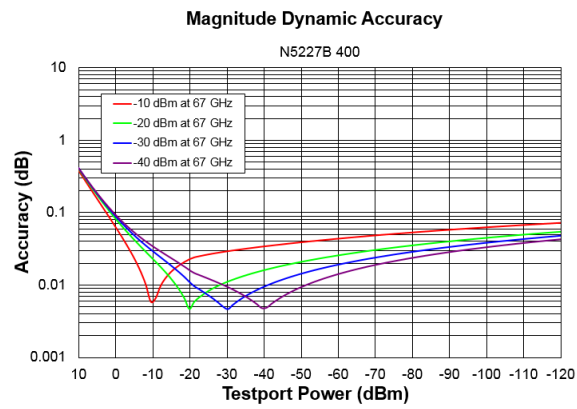
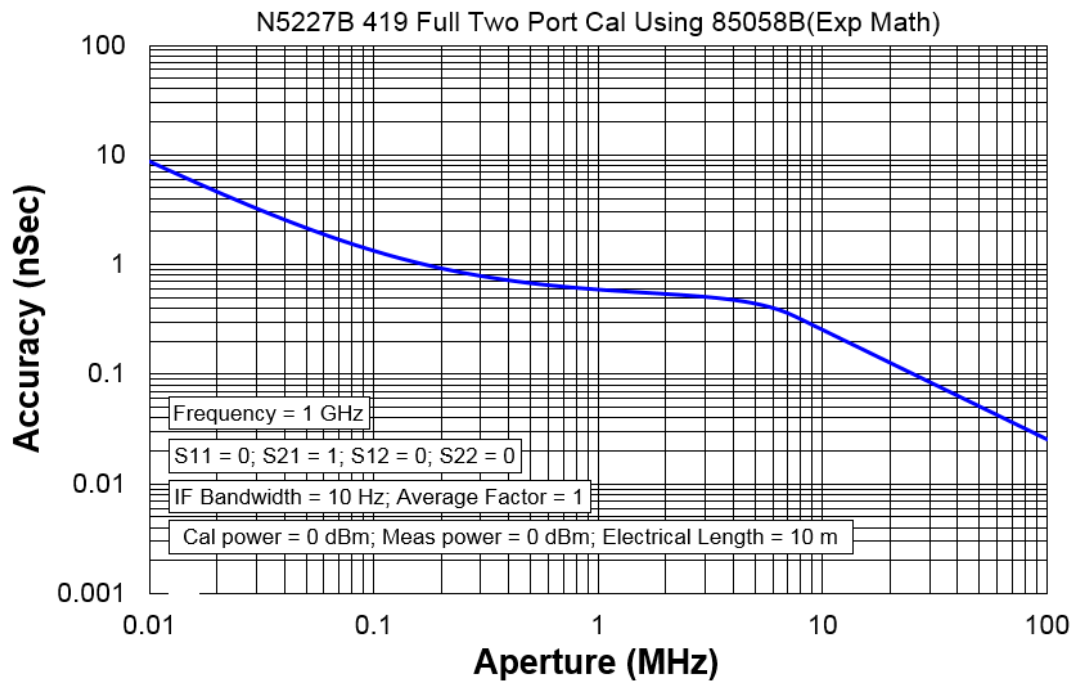

Table 72. Group Delay¹ - Typical

Description	Typical Performance
Aperture (selectable)	(frequency span)/(number of points -1)
Maximum Aperture	20% of frequency span
Range	0.5 x (1/minimum aperture)
Maximum Delay	Limited to measuring no more than 180° of phase change within the minimum aperture.)
Accuracy	See graph below. Char.

The following graph shows characteristic group delay accuracy with full 2-port calibration and a 10 Hz IF bandwidth. Insertion loss is assumed to be < 2 dB and electrical length to be ten meters.
 For any S_{ij} Group Delay measurement, S_{ii} = 0, S_{ij} = 1, S_{ji} = 0, S_{kl} = 0 for all kl ≠ ij

Group Delay Accuracy (Typical)



In general, the following formula can be used to determine the accuracy, in seconds, of specific group delay measurement:
 $\pm \text{Phase Accuracy (deg)} / [360 \times \text{Aperture (Hz)}]$
 Depending on the aperture and device length, the phase accuracy used is either incremental phase accuracy or worst-case phase accuracy.

¹ Group delay is computed by measuring the phase change within a specified frequency step (determined by the frequency span and the number of points per sweep).

General Information

Table 73. Miscellaneous Information

Description	Supplemental Information	
System IF Bandwidth Range	1 Hz to 15 MHz, nominal	
CPU	For the latest information on CPUs and associated hard drives, visit: <u>PNA Hard Drives and CPUs (keysight.com)</u>	
LXI	CPU version 7.0, 8.0	CPU version 9.0
	Class C	LXI 1.5 Extended Functions: HiSLIP; VSI-11 Discovery and Identification
Maximum Number of Points	100003	

Table 74. Front Panel Information, All Options

Description	Typical Performance
RF Connectors	
Type	1.85 mm (male), 50 ohm, (nominal)
Center Pin Recession	0.002 in. (characteristic)
USB 2.0 Ports - Primary (4 ports)	
Standard	Compatible with USB 2.0
Connector	USB Type-A female
Display	
Size	31 cm (12.1 in) diagonal color active matrix LCD; 1280 (horizontal) X 800 (vertical) resolution
Refresh Rate	Vertical 60 Hz; Horizontal 49.31 kHz
Pixels	Any of the following would cause a display to be considered faulty: <ul style="list-style-type: none"> • A complete row or column consists of “stuck” or “dark” pixels. • More than six “stuck on” pixels (but not more than three green) or more than 0.002% of the total pixels are within the LCD specifications. • More than twelve “dark” pixels (but no more than seven of the same color) or more than 0.004% of the total pixels are within the LCD specifications. • Two or more consecutive “stuck on” pixels or three or more consecutive “dark” pixel (but no more than one set of two consecutive dark pixels). • “Stuck on” pixels or more than two “dark” pixels less than 6.5 mm apart (excluding consecutive pixels).

Description	Typical Performance
Display Range	
Magnitude	± 2500 dB (at 500 dB/div), max
Phase	$\pm 2500^\circ$ (at 500 degrees/div), max
Polar	10 pUnits, min 10,000 Units, max
Display Resolution	
Magnitude	0.001 dB/div, min
Phase	0.01°/div, min
Marker Resolution	
Magnitude	0.001 dB, min
Phase	0.01°, min
Polar	10 pUnit, min

Table 75. Rear Panel Information, All Options

Description	Typical Performance
10 MHz Reference In	
Connector	BNC, female
Input Frequency	10 MHz ± 1 ppm, 100 MHz ± 1 ppm 20 MHz ± 1 ppm, 80 MHz ± 1 ppm
Input Level	10 MHz: -15 dBm to +20 dBm 100 MHz: -10 dBm to +20 dBm
Input Impedance	50 Ω , nom.
10 MHz Reference Out	
Connector	BNC, female
Output Frequency	10 MHz ± 0.7 ppm, 100 MHz ± 0.7 ppm
Signal Type	Sine Wave
Output Level	+10 dBm ± 4 dB into 50 Ω
Output Impedance	50 Ω , nominal
Harmonics	<-40 dBc, typical
External IF Inputs	
Function	Allows use of external IF signals from remote mixers, bypassing the PNA's first converters
Connectors	SMA (female); A, B, C, D, R (4-port); A, B, R1, R2 (2-port)
Input Frequency Normal IF path Narrowband IF path	RF < 53 MHz: IF = 826.446 KHz RF \geq 53 MHz: IF = 7.438 MHz IF = 10.70 MHz
Input Impedance	50 Ω
RF Damage Level	+23 dBm
DC Damage Level	5.5 VDC

Description	Typical Performance	
0.1 dB Compression Point Normal IF path Narrowband IF path	-9.0 dBm at 7.438 MHz -17 dBm at 10.70 MHz	
Pulse I/O Connector	15-pin mini D-sub (for pin assignment information, refer to the PNA online help)	
Pulse Inputs (IF Gates)		
Function	Internal receiver gates used for point-in-pulse and pulse-profile measurements	
Input Impedance	1 K Ohm	
Minimum Pulse Width, Source Modulators	33 ns	
Minimum Pulse Width, Receiver Gates	20 ns	
DC Damage Level	5.5 VDC	
Drive Voltage	0 V (off), +3.3 V (on), nominal	
RF Pulse Modulator Input (Source Modulator)		
On/Off Ratio		
10 MHz to 3.2 GHz	-64 dB	
3.2 GHz to 67 GHz	-80 dB	
Pulse Period		
Minimum	33 ns	
Maximum	70 s	
Pulse Outputs		
Voltage (TTL)	High: 3.3V to 3.5V Low: <1V	
Impedance	50 Ohm	
External Test Set Driver		
Function	Used for driving remote mixers	
Connections	3.5 mm (female)	
RF Output Frequency Range	3.2 GHz to 19 GHz	
LO Output Frequency Range	0.01 GHz to 26.5 GHz	
Rear Panel LO Power	Upper Limit, Typical (dBm)	Lower Limit, Typical (dBm)
10 MHz to 1.7 GHz	--	--
1.7 GHz to 16 GHz	5	-3
16 GHz to 21 GHz	0	-6
21 GHz to 26.5 GHz	4	-5
Rear Panel RF1 / RF2 Power	Maximum Output Power, Typical (dBm)	
3.2 GHz to 5 GHz	+3	
5 GHz to 19 GHz	+8	
Bias Tee Inputs		
Connectors	BNC(f) for ports 1, 2, 3 and 4	
Fuse	500 mA, bi-pin style	

Description	Typical Performance	
Maximum Bias Current	±200 mA with no degradation of RF specifications	
Maximum Bias Voltage	±40 VDC	
Other Rear Panel Interface		
Trigger Inputs/Outputs	BNC(f), TTL/CMOS compatible	
Test Set IO	25-pin D-Sub connector, available for external test set control	
Power IO	9-pin D-Sub, female; analog and digital IO	
Handler IO	36-pin parallel I/O port; all input/output signals are default set to negative logic; can be reset to positive logic via GPIB command	
GPIB	Two ports - dedicated controller and dedicated talker/listener. 24-pin D-sub (Type D-24), female; compatible with IEEE-488	
CPU Version	CPU version 7.0, 8.0	CPU version 9.0
PCIe	Cabled PCIe x4 connector is a 4-lane slot	N/A
USB Ports	Two SuperSpeed USB ports (900 mA each), one USB port below LAN connector, and one USB device port. There are also four USB ports (500 mA each) on the front panel. The total current limit for all rear panel USB ports is 2.3 amps. The total current limit for all front panel USB ports is 2 amps.	Four SuperSpeed USB ports (900 mA each) and one USB device port. There are also four USB ports (500 mA each) on the front panel. The total current limit for all rear panel USB ports is 3.6 amps. The total current limit for all front panel USB ports is 2 amps.
USB-C (Host)	N/A	Two USB-C connectors with support for USB-3.1 (max Power Delivery of 5V@1A), Thunderbolt3 (max Power Delivery of 5V@1A) ¹ , and Display Port (port TB1 only)
LAN	1G port; 10/100/1000 BaseT Ethernet, 8-pin configuration; auto selects between the data rates	1G and 10G ports; 10GBASE-T, Ethernet, 8-pin configuration; auto selects between the data rates. Works with Cat6/Cat7 cable.
VGA Video Output	15-pin mini D-Sub; Drives VGA compatible monitors	N/A
Mini DisplayPort	Miniature DisplayPort connector for connection to external displays	N/A
DisplayPort	N/A	Standard DisplayPort connector for connection to external displays
Line Power		
Frequency, Voltage	50/60/400 Hz for 100/120 VAC 50/60 Hz for 220/240 VAC	
	Power supply is auto switching	
Max	575 watts	

¹ High power devices require external power supply.

Table 76. Analyzer Dimensions and Weight

All models are shipped with bottom feet, handles and front and rear hardware.

Cabinet Dimensions	Metric (mm)	Imperial (inches)
Height		
Without bottom feet:EIA RU ¹ = 6	266.1	10.5
With bottom feet	279.1	11.0
Width		
Without handles or rack-mount flanges	425.6	16.8
With handles, without rack-mount flanges	458.7	18.1
With handles and rack-mount flanges	482.9	19.0
Depth		
Without front and rear panel hardware	582.3	22.9
With front and rear panel hardware, handles	649.6	25.6
Weight (nominal)	Net	Shipping
All 2-port models	42.2 kg (93 lb)	57.6 kg (127 lb)
All 4-port models	44.9 kg (99 lb)	60.3 kg (133 lb)

¹ Electronics Industry Association rack units. 1 RU = 1.75 in.

Regulatory and Environmental Information

For Regulatory and Environmental information, refer to the PNA Series Installation and Quick Start Guide, located online at <http://literature.cdn.keysight.com/litweb/pdf/E8356-90001.pdf>.

Measurement Throughput Summary

Cycle time Includes sweep time, retrace time and band-crossing time. Analyzer display turned off with DISPLAY:ENABLE OFF. Add 21 ms for display on. Data for one trace (S11) measurement. LF Auto BW off.

Table 77. Cycle Time (ms) for Measurement Completion, All Models, All Options - Typical

Sweep Range	IF Bandwidth		Number of Points				
			201	401	1601	16001	32001
50 kHz to 100 MHz	10kHz	Uncorrected	56.7	104.8	406	1991	3977
		2-Port cal	113.1	211.5	811	3980	7950
	1kHz	Uncorrected	232.3	459	1822	18176	3976
		2-Port cal	464	919	3644	36349	7949
	100Hz	Uncorrected	1830	3647	14550	145410	3977
		2-Port cal	3660	7294	29098	290792	7950
9 GHz to 10 GHz	600 kHz	Uncorrected	3.8	4.4	8.2	54.5	103.7
		2-Port cal	7.7	8.9	16.4	108.1	208.3
	10 kHz	Uncorrected	28.2	53.4	202	1990	3976
		2-Port cal	56.2	107	404	3978	7949
	1 kHz	Uncorrected	201.5	399	1585	15814	31622
		2-Port cal	403	798	3169	31625	63346
10 GHz to 20 GHz	600 kHz	Uncorrected	12.9	13.1	14.2	58.4	108.7
		2-Port cal	25.6	25.7	28.9	117.9	215.8
	10 kHz	Uncorrected	43.6	81.6	207.3	1995	3984
		2-Port cal	87.1	163	411	3991	7959
	1 kHz	Uncorrected	204.8	402	1588	15817	31625
		2-Port cal	408	803	3175	31630	63358

Table 78. Cycle Time (ms) for Full-Span Measurement Completion - Typical

10 MHz to 67 GHz		Number of Points				
IF Bandwidth		201	401	1601	16001	32001
600 kHz	Uncorrected	36.7	48.7	83	108	157.5
	2-Port cal	72.9	99.6	167.4	215.8	320
10 kHz	Uncorrected	60.1	100.4	335	2155	4257
	2-Port cal	120.5	201.3	670	4308	8511
1 kHz	Uncorrected	221	421	1620	15912	31798
	2-Port cal	441	841	3228	31822	63716

Table 79. Cycle Time vs. IF Bandwidth - Typical

Applies to the **Preset condition** (201 points, correction off) except for the following changes:

- CF = 10 GHz
- Span = 100 MHz
- Display off (add 21 ms for display on)

Cycle time includes sweep and retrace time.

Description	N5227B	
	IF Bandwidth (Hz)	Trace Noise Magnitude (dB rms)
	Cycle Time (ms)	
600,000	2.6	0.0044
100,000	3.7	0.0021
30,000	7.1	0.0011
10,000	27.1	0.0007
3,000	69.5	0.0006
1,000	200.8	0.0004
300	617	0.0004
100	1799	0.0003
30	5955	0.0003
10	17804	0.0003
3	59247	0.0003

Table 80. Cycle Time (ms) vs. Number of Points - Typical

Applies to the **Preset condition** (correction off) except for the following changes:

- CF = 10 GHz
- Span = 100 MHz
- Display off (add 21 ms for display on)

Cycle time includes sweep and retrace time.

Description	IF Bandwidth (Hz)			
	1,000	10,000	30,000	600,000
Number of Points				
3	7.8	6.3	6.3	6.3
11	16.4	6.3	6.3	6.3
51	60	11	6.3	6.3
101	114	17.2	7	6.3
201	223	29.7	9.4	6.3
401	437	54.7	14.9	7.1
801	862	105	25	7.8
1,601	1708	205	46	11
6,401	6728	805	169	30.5
16,001	16672	2005	417	68.8
32,001	33112	4006	833	134

Table 81. Data Transfer Time¹ (ms) - Typical

NOTE The following was measured on a unit with Synthesizer 6.

Description	Number of Points				
	201	401	1601	16,001	32,001
SCPI over GPIB (Program executed on external PC ²)					
32-bit floating point	4.6	9.3	38	352	720
64-bit floating point	9.4	18.8	73.4	730	1455
ASCII	36.7	72.5	288	2882	5762
SCPI over SICT/LAN or TCP/IP Socket ³ (Program executed in the analyzer)					
32-bit floating point	<1	<1	<1	1.2	2.4
64-bit floating point	<1	<1	<1	2.3	4.6
ASCII	2.1	4	15	148	295
COM ¹ (Program executed in the analyzer)					
32-bit floating point	<1	<1	<1	<1	<1
Variant type	<1	<1	1.4	12.4	25.5
DCOM over LAN ³ (Program executed on external PC)					
32-bit floating point	<1	<1	<1	2.3	4.4
Variant type	<1	1.6	5.3	52	105.5

¹ Measured with the analyzer display off. Values will increase slightly if the analyzer display is on.

² Measured when using the SCPI command DISPlay:VISible OFF.

³ Values are for real and imaginary pairs, with the analyzer display off, using Gigabit Ethernet.

NOTE Specifications for Recall & Sweep Speed are not provided for the N522xB analyzers.

Front-Panel Jumpers



NOTE

The following options have front-panel jumpers for each port:
201, 205, 219, 220, 401, 405, 419, 420

Table 82. Measurement Receiver Inputs (dBm) - Typical

(RCVR A, B, C, D IN) @ 0.1dB Typical Compression

Description	N5227B
10 MHz to 500 MHz	-3
500 MHz to 3.2 GHz	-4
3.2 GHz to 26.5 GHz	-5
26.5 GHz to 50 GHz	-4
50 GHz to 64 GHz	-3
64 GHz to 67 GHz	-4
67 GHz to 70 GHz	-2

Table 83. Port 1 Reference Receiver Inputs and Reference Source Outputs (dBm) - Typical
 (RCVR R1 IN, REF 1 SOURCE OUT) @ Max Specified Output Power

Description	Option 201, 401	Option 219, 419
10 MHz to 50 MHz	-30	-30
50 MHz to 500 MHz	-16	-16
500 MHz to 1 GHz	-9	-9
1 GHz to 2 GHz	-6	-5
2 GHz to 3.2 GHz	-10	-11
3.2 GHz to 10 GHz	-8	-9
10 GHz to 16 GHz	-10	-11
16 GHz to 26.5 GHz	-11	-12
26.5 GHz to 30 GHz	-13	-14
30 GHz to 32 GHz	-16	-16
32 GHz to 35 GHz	-14	-15
35 GHz to 40 GHz	-17	-14
40 GHz to 70 GHz	-12	-14

Table 84. Port 2, 3, 4 Reference Receiver Inputs and Reference Source Outputs (dBm) - Typical

(RCVR R2 IN, RCVR R3 IN, RCVR R4 IN, REF 2 SOURCE OUT, REF 3 SOURCE OUT, REF 4 SOURCE OUT) @ Max Specified Output Power

Description	Option 201, 401	Option 401	Option 219, 419	Option 419
	RCVR R2 IN, RCVR R4 IN, REF 2 SOURCE OUT, REF 4 SOURCE OUT	RCVR R3 IN, REF 3 SOURCE OUT	RCVR R2 IN, RCVR R4 IN, REF 2 SOURCE OUT, REF 4 SOURCE OUT	RCVR R3 IN, REF 3 SOURCE OUT
10 MHz to 50 MHz	-25	-25	-25	-25
50 MHz to 500 MHz	-6	-6	-10	-10
500 MHz to 1 GHz	-4	-4	-4	-4
1 GHz to 2 GHz	-1	-1	-1	-1
2 GHz to 3.2 GHz	-5	-1	-6	-1
3.2 GHz to 10 GHz	-1	-1	-2	-2
10 GHz to 16 GHz	-3	-3	-4	-4
16 GHz to 26.5 GHz	-4	-4	-4	-4
26.5 GHz to 30 GHz	-4	-4	-5	-5
30 GHz to 32 GHz	-6	-6	-7	-7
32 GHz to 35 GHz	-4	-4	-5	-5
35 GHz to 40 GHz	-8	-8	-9	-9
40 GHz to 50 GHz	-2	-2	-4	-4
50 GHz to 60 GHz	-1	-1	-3	-3
60 GHz to 64 GHz	0	0	-2	-2
64 GHz to 67 GHz	1	1	-3	-3
67 GHz to 70 GHz	0	0	-1	-1

Table 85. Source Outputs (dBm) - Typical(PORT 1 SOURCE OUT, PORT 2 SOURCE OUT, PORT 3 SOURCE OUT, PORT 4 SOURCE OUT) @
Max Specified Output Power

Description	Option 201, 401		Option 219, 419	
	PORT 1 SOURCE OUT, PORT 3 SOURCE OUT	PORT 2 SOURCE OUT, PORT 4 SOURCE OUT	PORT 1 SOURCE OUT, PORT 3 SOURCE OUT	PORT 2 SOURCE OUT, PORT 4 SOURCE OUT
10 MHz to 50 MHz	12	12	11	11
50 MHz to 1 GHz	13	13	13	13
1 GHz to 2 GHz	14	14	14	14
2 GHz to 3.2 GHz	11	14	10	14
3.2 GHz to 10 GHz	14	14	12	13
10 GHz to 16 GHz	13	13	11	11
16 GHz to 26.5 GHz	13	13	10	10
26.5 GHz to 30 GHz	12	12	10	10
30 GHz to 32 GHz	9	9	8	8
32 GHz to 35 GHz	11	11	9	9
35 GHz to 40 GHz	7	7	5	5
40 GHz to 60 GHz	13	13	12	12
60 GHz to 64 GHz	14	14	13	13
64 GHz to 70 GHz	14	14	12	12

Table 86. Coupler Inputs (dB) - Typical

(PORT 1, 2, 3, 4 CPLR THRU) Insertion Loss of Coupler Thru

Description	Options 201, 401	Option 219, 419
10 MHz to 50 MHz	0	0
50 MHz to 500 MHz	-0.25	-0.25
500 MHz to 1 GHz	-0.5	-0.5
1 GHz to 2 GHz	-0.5	-1.0
2 GHz to 3.2 GHz	-0.75	-1.0
3.2 GHz to 10 GHz	-1.0	-1.5
10 GHz to 16 GHz	-1.2	-2.0
16 GHz to 26.5 GHz	-1.8	-2.5
26.5 GHz to 35 GHz	-2.0	-3.0
35 GHz to 40 GHz	-2.5	-4.0
40 GHz to 50 GHz	-3.0	-6.0
50 GHz to 60 GHz	-3.6	-7.2
60 GHz to 64 GHz	-3.8	-7.7
64 GHz to 67 GHz	-4.0	-8.0
67 GHz to 70 GHz	-4.2	-8.4

Table 87. Damage Level - Typical

Description	RF (dBm)	DC (v)
RCVR A, B, C, D IN	15	7
RCVR R1, R2, R3, R4 IN	15	7
REF 1 SOURCE OUT	15	7
REF 2, 3, 4 SOURCE OUT	30	7
PORT 1, 2, 3, 4 SOURCE OUT	27	7
PORT 1, 2, 3, 4 CPLR THRU	27 (20 ¹)	40 (50 ¹)
PORT 1, 2, 3, 4 CPLR ARM	30	7

¹ With an LFE option installed.

Test Set Block Diagrams

NOTE

For best readability, use a color printer for printing the following graphics.

Legend

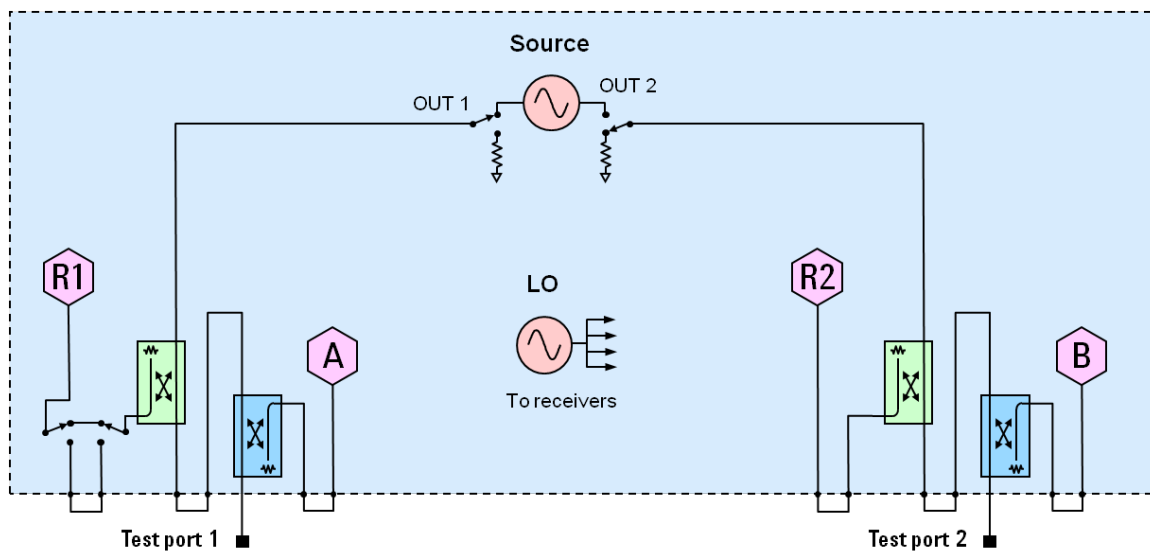
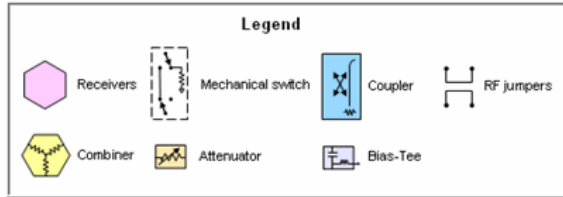

Figure 1. N5227B Option 200 (2-port base model)

To base model, adds front-panel jumpers and R1 receiver switch

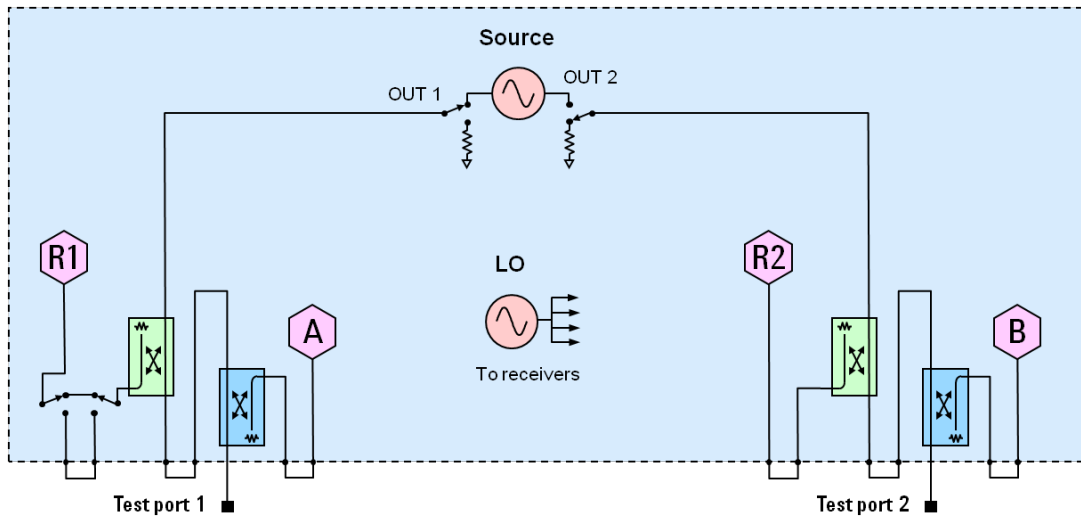

Figure 2. N5227B Option 201

To base model, adds front-panel jumpers, R1 receiver switch, source and receiver attenuators (extended power range), and bias-tees.

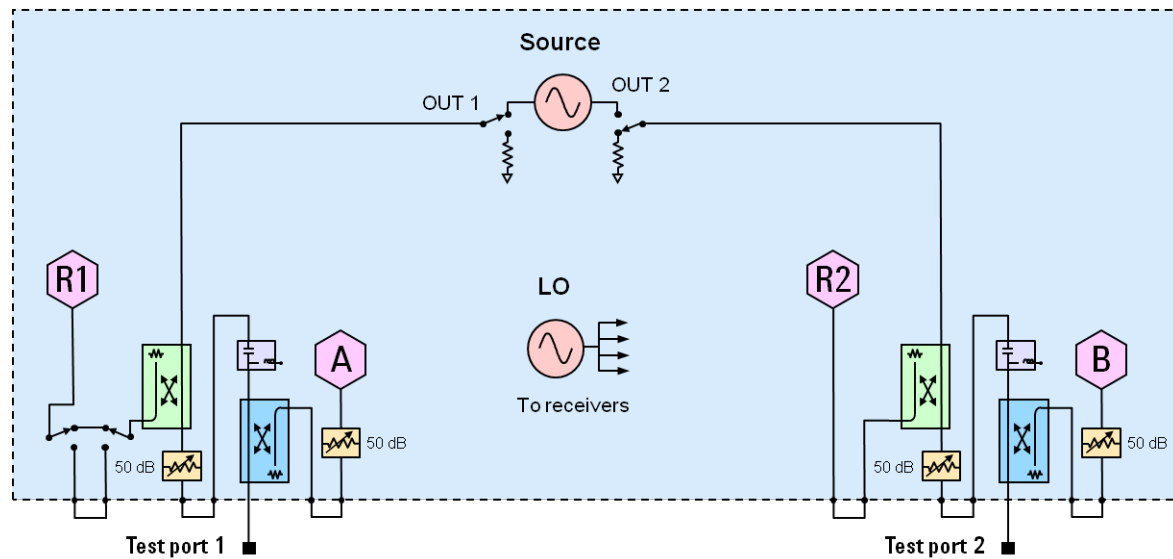

Figure 3. N5227B Option 219

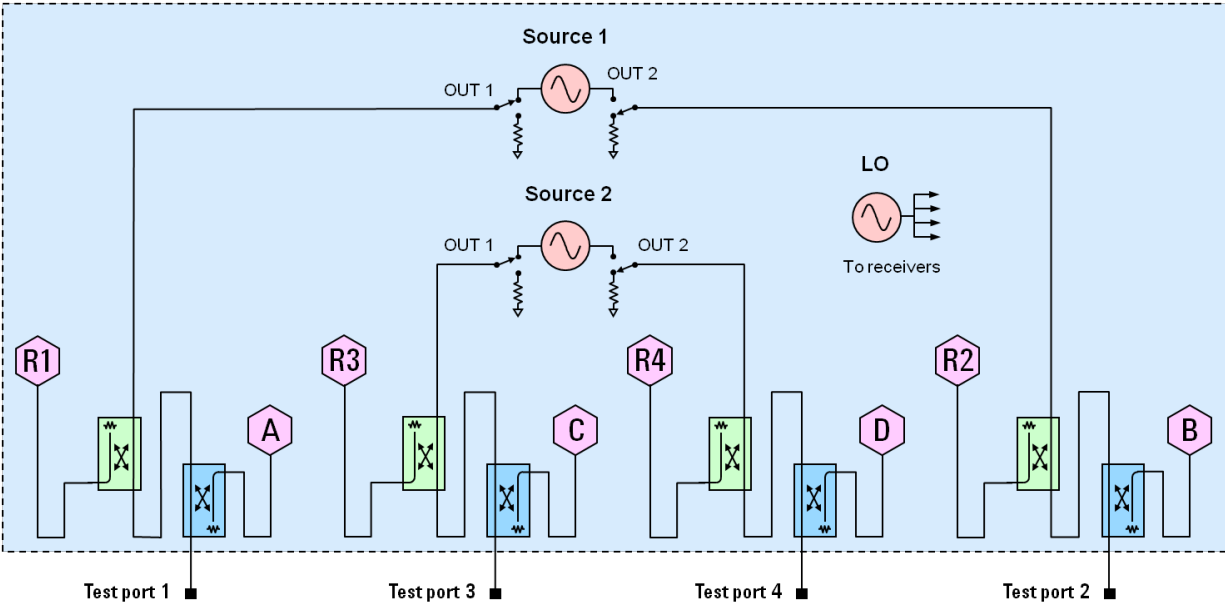

Figure 4. N5227B Option 400 (4-port base model)

To base model, adds front-panel jumpers and R1 receiver switch

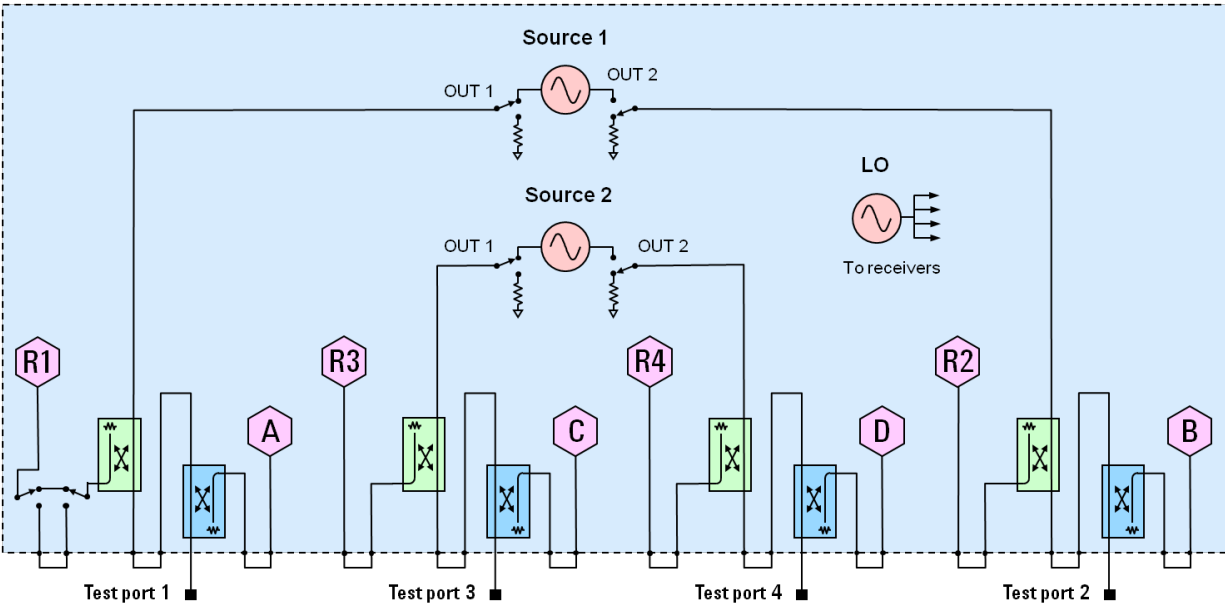

Figure 5. N5227B Option 401

To base model, adds front-panel jumpers, R1 receiver switch, source and receiver attenuators (extended power range), and bias-tees.

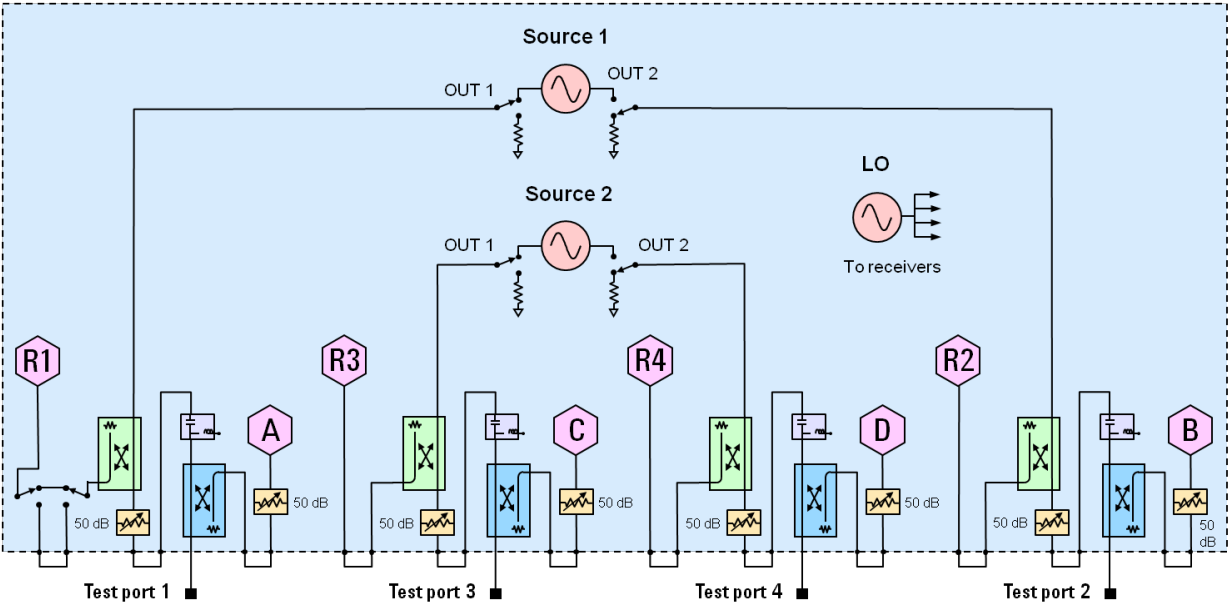

Figure 6. N5227B Option 419

The following LFE block diagram shows how the low-frequency hardware is configured for a single test port. The other ports are configured similarly.

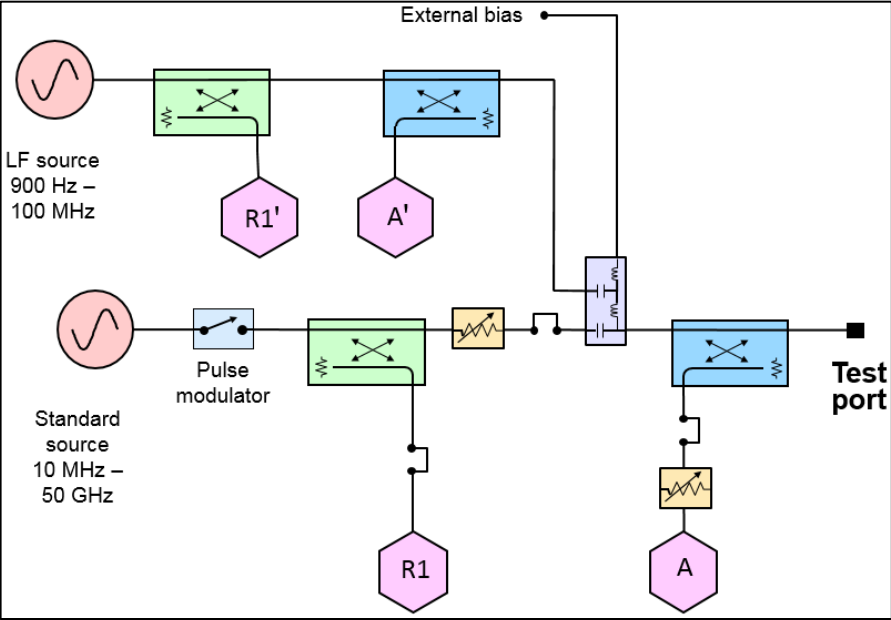

Figure 7. N5227B LFE Options

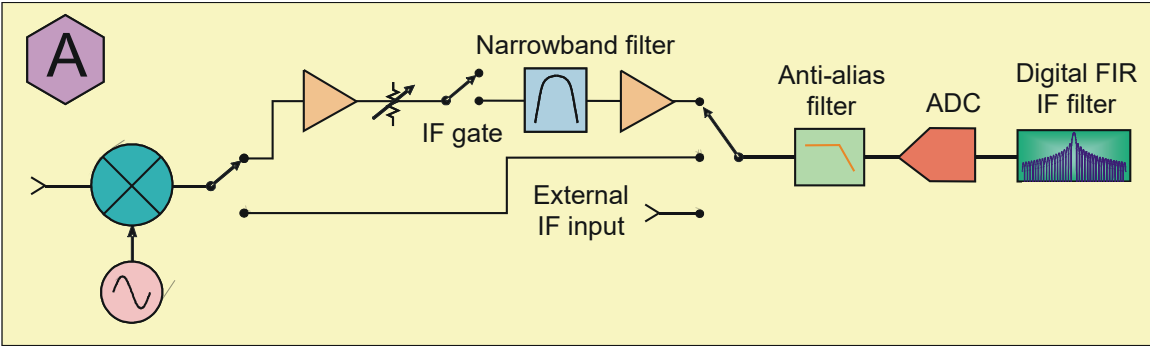

Figure 8. Receiver Block Diagram

This information is subject to change without notice.
© Keysight Technologies 2017-2025
Print Date: July 22, 2025



N5227-90005